



vacu  
vin

[vacuvin.com](http://vacuvin.com)

Surprise  
your senses



“You don’t have to be  
a sommelier to enjoy wine.”

As the inventor of the Original Wine Saver and global market leader in wine accessories, we develop innovative and high-quality products that will enable our customers to enjoy their beverages to the fullest.

Since the founding in 1986, we differentiate our products by Dutch design with unique functions, patented technology and European quality.

As a socially involved company, we carry out most of our assembly and packaging activities at our social production facility Voor Elkaar. Here people less capable of working in an ordinary work environment get extra help and guidance to participate in the labor process.

Our passion for wine, innovative drive, social character and Dutch roots define who we are – We are the Original.

## Index

<b>6</b>	OPEN
<b>10</b>	CHILL
<b>14</b>	SERVE
<b>17</b>	STORE
<b>21</b>	BARWARE
<b>24</b>	KITCHEN
<b>27</b>	GIFT SETS
<b>30</b>	SPECIFICATIONS





“We develop innovative, high-quality products that will enable you to enjoy wine more intensely than ever before”

After the global successful introduction of the first Wine Saver in 1986 we felt a drive to continuously improve The Original Vacu Vin Wine Saver. Since 2001 all our Wine Savers make a “click” sound to indicate that the optimum vacuum is reached. This innovation distinguished us clearly from copy products. Moreover, we patented the new Vacuum Stoppers that prevented the vacuum seal from leaking and this breakthrough secured our global market position.

The redesign of the Vacu Vin Wine Saver grip in 2006 was an ode to The Original Wine Saver of 1986. In 2017 we have introduced The Wine Saver & Server. This product combines vacuum sealing with drip-free pouring. As a global market leader of wine accessories we will keep innovating to maximize the enjoyment of fine wine.

Unique products with a unique story

How winemakers treat their grapes with care, is equal to the responsibility we feel for our employees. Vacu Vin products are made with care in our social production facility in the Netherlands, where we

provide people a job in a sheltered environment. Our employees get support and guidance to find their qualities and develop their self-confidence.

### The core values of Vacu Vin



THE ORIGINAL



INNOVATIVE



QUALITY



SOCIAL



68854606

## SINGLE PULL CORKSCREW

- EN | The Single Pull Corkscrew extracts all corks from the bottle in one smooth and perfect vertical motion. The patented lever mechanism makes this an unique corkscrew, comfortable in use. The grip contains a foil cutter and crown cap opener. Opening wine bottles is a pleasure with this premium corkscrew.
- FR | Le tire-bouchon Single Pull débouche votre vin d'un seul mouvement à la verticale grâce au mécanisme à levier patenté unique. Le manche est équipé non seulement d'un découpe-capsule, mais aussi d'un décapsuleur. Ouvrir une bouteille de vin devient une plaisir avec ce tire-bouchon premium.
- ES | El sacacorchos Single Pull saca el corcho de la botella con un perfecto y delicado movimiento vertical. El mecanismo de palanca patentado hace de éste un sacacorchos único, cómodo en su uso. El mango contiene un corta cápsulas y un abridor de chapa. Abrir botellas de vino es un placer, con este sacacorchos superior.
- DE | Der Single Pull Waiter's Friend zieht alle Korke in einer gleichmäßigen und perfekt vertikalen Bewegung aus der Flasche. Der patentierte Hebelmechanismus macht dieses Kellnermesser einzigartig. Der Griff enthält einen Folienschneider und einen Kronkorkenöffner. Das Öffnen von Weinflaschen ist mit diesem Premium-Kellnermesser ein Vergnügen.



68514606

## DOUBLE HINGED CORKSCREW

- EN | The Double Hinged Corkscrew easily opens wine bottles with a two-step motion. Includes a built-in foil cutter and crown cork opener.
- FR | Le tire-bouchon sommelier à deux crans utilise la technique du levier pour ouvrir une bouteille rapidement et sans effort. Equipé d'un découpe-capsule et décapsuleur.
- ES | El sacacorchos dos tiempos abre fácilmente botellas de vino en dos pasos. Incluye un corta cápsulas integrado y un abridor de tapón de corcho.
- DE | Das Kellnermesser öffnet Weinflaschen in zwei Schritten und beinhaltet einen integrierten Folienschneider, sowie Kronkorkenöffner.



68504606

## WAITER'S CORKSKREW

- EN | The Waiter's Corkscrew is a straight forward wine opener with a built-in foil cutter and crown cork opener.
- FR | Ce tire-bouchon à 1 cran ouvre une bouteille rapidement et sans effort, équipé d'un coupe-capsule et d'un décapsuleur.
- ES | El Sacacorchos de camarero es un abridor de vino compacto con un corta cápsulas integrado y un abridor de chapa.
- DE | Der Kellnerkorkenzieher ist ein unkomplizierter Weinöffner mit integriertem Folienschneider und Kronkorkenöffner.



68814606

## CORKSCREW TWISTER

- EN | The Corkscrew Twister makes opening wine bottles easier with its comfortable twist-handle and firm grip on the bottle.
- FR | Le tire-bouchon Twister est facile dans son utilisation, grâce au mécanisme solide de fixation du grip sur le col de la bouteille.
- ES | El sacacorchos Twister permite abrir las botellas de vino más fácilmente con su mango giratorio y la fuerte sujeción a la botella.
- DE | Der Korkenzieher „Twister“ erleichtert das Öffnen von Weinflaschen durch seinen komfortablen Drehgriff und dem festen Sitz auf der Flasche.



68423606

## WINGED CORKSCREW

- EN | The Winged Corkscrew has sturdy lever arms that make it easier to open a bottle of wine.
- FR | Le tire-bouchon à Ailettes avec ses leviers robustes permettent une extraction très facile sans endommager le bouchon.
- ES | El sacacorchos con alas tiene unos robustos brazos de palanca que hacen más fácil abrir una botella de vino.
- DE | Der Flügelkorkenzieher hat robuste Hebelarme, die das Öffnen einer Flasche Wein erleichtern.





66514606

## LEVER CORKSCREW

EN | The Lever Corkscrew opens wine bottles in style while having a firm grip. Extracts corks with little effort by moving the lever up and down.

FR | Le tire-bouchon à levier permet de déboucher une bouteille de vin avec un minimum d'effort en abaissant et relevant la poignée.

ES | El sacacorchos de palanca abre la botella de vino con estilo, y al mismo tiempo posee un agarre firme. Extrae los corchos con poco esfuerzo moviendo la palanca arriba y abajo.

DE | Der Hebelkorkenzieher öffnet Weinflaschen mit Stil. Der Korkenzieher entfernt Korke mit geringem Kraftaufwand, indem der Hebel auf und ab bewegt wird.



68405606

## CORK PULLER

EN | This Cork Puller is the perfect instrument to extract damaged or brittle corks. Includes a case to protect the tongs.

FR | Le tire-bouchon Bilame est parfait pour extraire les bouchons fragiles ou endommagés. Les 2 lames sont protégées dans un étui.

ES | El tirador de corcho es el instrumento perfecto para extraer los corchos dañados o frágiles. Incluye un estuche para proteger las pinzas.

DE | Dieser Korkenzieher, inkl. Etui zum Schutz der Zange ist perfekt, um beschädigte oder spröde Korke zu entfernen.



68544606

## FOIL CUTTER

EN | The Foil Cutter with 4 knives neatly removes the capsule of wine bottles. Includes a special holder for the extracted cork.

FR | Le découpe-capsule est muni de 4 petites molettes, qui découpe rapidement la capsule protectrice de la bouteille de vin. Equipé d'une porte-bouchon décoratif.

ES | El corta cápsulas de 4 cuchillas quita eficientemente la cápsula de las botellas de vino. Incluye un apoyo especial para dejar el corcho extraído.

DE | Der Folienschneider mit 4 Messern entfernt die Kapsel der Weinflaschen sauber und beinhaltet eine spezielle Halterung für den entfernten Korke.



68615606

## CHAMPAGNE OPENER

EN | The Champagne Opener makes it safe and easy to open champagne bottles without popping the cork by twisting the bottle.

FR | La griffe ouvre-bouteille assure une bonne prise sur le bouchon lors de l'ouverture de la bouteille de champagne et une ouverture silencieuse.

ES | El abridor de cava hace fácil y seguro abrir botellas de cava sin tener que disparar el corcho moviendo la botella.

DE | Mit dem Champagneröffner lassen sich Champagnerflaschen sicher und einfach öffnen, ohne dass der Korke durch das Drehen der Flasche herausplatzt.



68625606

## CHAMPAGNE BOTTLE OPENER

EN | The Champagne Bottle Opener removes the foil, wire cage and cork of the champagne bottle in one motion.

FR | La pince ouvre-bouteille à Champagne est conçue pour enlever capsule, filet de métal et bouchon d'un seul mouvement.

ES | El abridor de botellas de cava quita la cápsula, la jaula de alambre y el corcho de la botella de cava en un solo movimiento.

DE | Die Champagnerflaschenzange entfernt die Folie, den Drahtkäfig und den Korke der Champagnerflasche in einer Bewegung.





NEW ARRIVAL

38864606



### FLEXIBLE WINE COOLER ARTICO

EN | The Flexible Wine Cooler Artico is the flexible cooler for both wine and champagne. With the active cooling technique, the Flexible Wine Cooler Artico chills your wine quickly and keeps it cool until the last sip. The neoprene sleeve and leather strip gives a premium appearance.

FR | Machon Refroidisseur Flexible Artico pour le vin et le champagne. Refroidit en peu de temps grâce au gel cryogénique et garde les boissons fraîches jusqu'à la dernière gorgée. Le tissu extensible et la bande en cuir donne une apparence premium.

ES | El Enfriador de Vino Flexible Artico es el enfriador flexible apto para vino y para cava. Con la técnica de enfriar activamente, el Enfriador de Vino Flexible Artico refrigera su vino rápidamente y lo mantiene frío hasta el último sorbo. La manga de neopreno y la tira de cuero le da una apariencia suprema.

DE | Der Flexibler Weinkühler Artico ist der flexible Kühler für Wein und Champagner. Mit der aktiven Kühltechnik kühlt der Flexibler Weinkühler Artico Ihren Wein schnell und hält ihn bis zum letzten Schluck kalt. Die Neoprenhülle und der Lederstreifen sorgen für ein erstklassiges Erscheinungsbild.

### ACTIVE COOLERS

EN | The Active Cooler Wine / Champagne actively chills bottles by using a reusable cooling element. The flexible cooling sleeve has insulating properties and fits tightly around the bottle. Keep the cooling element in the freezer to enjoy a cold wine or champagne for a longer period of time.

FR | Le rafraîchisseur à vin / champagne refroidit immédiatement vos bouteilles en utilisant un manchon réutilisable. Ce manchon flexible composé d'une paroi extérieure isolante glisse autour de la bouteille. Conservez au congélateur et votre vin ou champagne sera toujours prêt à servir frais.

ES | El enfriador activo de vino/ cava enfría activamente las botellas usando un elemento enfriador reutilizable. La manga enfriadora tiene propiedades aislantes y encaja perfectamente alrededor de la botella. Guarde el elemento enfriador en el congelador para poder disfrutar de un vino o cava fresco por más tiempo.

DE | Der Aktivkühler für Wein und Champagner kühlt Flaschen mithilfe eines wiederverwendbaren Kühlelements. Die flexible Kühlmanschette hat isolierende Eigenschaften und liegt eng um die Flasche. Bewahren Sie das Kühlelement im Gefrierschrank auf, um einen kalten Wein oder Champagner über einen längeren Zeitraum zu genießen.

#### How to use the Active Cooler

Follow these four simple steps to enjoy a cold drink in a fast and easy way. The Active Cooler is available in various designs for wine, beer and champagne.

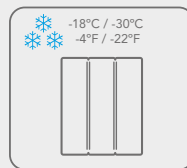

Store the cooling element in the freezer for at least 6 hours

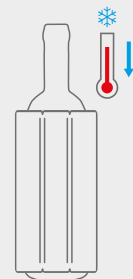

Chills bottles with the active cooling technique

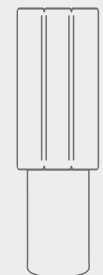

Slide the frozen cooling element around the bottle



Keeps chilled bottles cool for a longer period of time

### ACTIVE COOLER WINE



SILVER  
38803606

PLATINUM  
38805626

BLACK  
38804606

GRAPES  
38814606

### ACTIVE COOLER CHAMPAGNE



PLATINUM  
38855626

BOTTLES  
38854606

BLACK  
38856606



3887560

### ACTIVE COOLERS WINE & CHAMPAGNE

1 x Active Cooler Wine Platinum  
1 x Active Cooler Champagne Platinum

## ACTIVE COOLER WINE LIMITED EDITION

EN | Special designs based on the latest home & lifestyle trends to bring ambiance to the table! The Active Cooler Wine actively chills bottles by using a reusable cooling element. Keep the cooling element in the freezer to enjoy a cold wine or champagne for a longer period of time.

FR | Décors spéciales basés sur les dernières tendances « maison & vie » qui apporte l'ambiance sur la table! Le rafraîchisseur à vin refroidit immédiatement vos bouteilles en utilisant un manchon réutilisable. Conservez au congélateur et votre vin ou champagne sera toujours prêt à servir frais.

ES | Diseños especiales basados en las últimas tendencias de moda y hogar, para dar ambiente a la mesa! El enfriador activo de vino enfría activamente las botellas usando un elemento enfriador reutilizable. Guarde el elemento enfriador en el congelador para poder disfrutar de un vino o cava fresco por más tiempo.

DE | Besonderen designs die auf den neuesten Home & Lifestyle-Trends basieren, bringen Ambiente auf den Tisch! Der Aktivkühler für Wein kühlt Flaschen mithilfe eines wiederverwendbaren Kühlelements. Bewahren Sie das Kühlelement im Gefrierschrank auf, um einen kalten Wein oder Champagner über einen längeren Zeitraum zu genießen.



**BOTANICAL**  
38829606

**MARBLE**  
38829616

**ROYAL GOLD**  
38829626

NEW ARRIVAL



**BLACK**  
3649460

**STAINLESS STEEL**  
3649360

## ACTIVE COOLER WINE ELEGANT

EN | The Wine Cooler Elegant has a reusable cooling element which actively chills wine bottles. Keep the cooling element in the freezer to enjoy a cold wine for a longer period of time. The elegant casing makes this a functional and stylish wine cooler.

FR | Le seau à vin contient un refroidisseur réutilisable qui refroidit immédiatement votre bouteille. Conservez le refroidisseur dans le congélateur pour garder votre vin frais pendant des heures. Un produit efficace et élégant.

ES | La cubitera enfriadora de vino tiene un elemento enfriador que enfría activamente las botellas de vino. Guarde el enfriador en el congelador para poder disfrutar de un vino fresco por más tiempo. La elegante cubitera hace de éste un estiloso y funcional enfriador de vino.

DE | Der Aktiv Weinkühler Elegant verfügt über ein wiederverwendbares Kühlelement, das Weinflaschen aktiv kühlt. Bewahren Sie das Kühlelement im Gefrierschrank auf, um einen kalten Wein länger genießen zu können. Das elegante Gehäuse macht das Produkt zu einem funktionalen und stilvollen Weinkühler.

3647360

## ACTIVE COOLER CHAMPAGNE ELEGANT

EN | The Active Cooler Champagne Elegant has the same reusable cooling element as the other Active Coolers. The stainless steel casing makes this a luxurious champagne cooler.

FR | Le seau à champagne en acier brossé contient un refroidisseur réutilisable qui refroidit immédiatement votre bouteille. Conservez au congélateur et votre champagne sera toujours prêt à servir frais.

ES | La cubitera enfriadora de cava elegant tiene los mismos elementos enfriadores que otros enfriadores activos. La carcasa de acero inoxidable hace de éste un lujoso enfriador de cava.

DE | Der Aktiv Champagnerkühler Elegant hat das gleiche wiederverwendbare Kühlelement wie die anderen Aktivkühler. Das Edelstahlgehäuse macht das Produkt zu einem luxuriösen Champagnerkühler.



**CELSIUS**  
3630360

## SNAP THERMOMETER

EN | The Snap Thermometer snaps around the bottle and shows the current temperature. Advised serving temperatures are integrated on the backside.

FR | Vous enroulez le bracelet autour de la bouteille de vin et la température apparaît aussitôt. Les températures de service conseillées sont indiquées au dos du thermomètre.

ES | El termómetro flexible se fija alrededor de la botella y muestra la temperatura actual. En la parte trasera hay consejos sobre las temperaturas a las que servir el vino.

DE | Das Weinthermometer schnappt um die Flasche und zeigt die aktuelle Temperatur an. Empfohlene Serviertemperaturen sind auf der Rückseite integriert.

3645460

## ACTIVE COOLING CARAFE

EN | The Active Cooling Carafe holds two reusable cooling elements which actively chill the glass carafe to enjoy all kinds of cold beverages.

FR | La Carafe contient 2 éléments refroidisseurs qui vont refroidir la carafe en verre et pour conserver vos boissons fraîches.

ES | La garrafa enfriadora activa tiene dos elementos enfriadores reutilizables que enfrían el cristal de la garrafa para disfrutar de todo tipo de bebida fresca.

DE | Die Aktiv Kühlkaraffe enthält zwei wiederverwendbare Kühlelemente, die die Glaskaraffe aktiv kühlen, um alle Arten von kalten Getränken zu genießen.



38549606

## ACTIVE COOLER BEER

EN | The Active Cooler Beer can be stored in the freezer and be used to slip over beer bottles to chill them in minutes.

FR | Refroidisseur à bière à conserver au congélateur. Le manchon se glisse autour de la bouteille et vous permettra de rafraîchir votre boisson dans quelques minutes.

ES | El enfriador de cerveza activo se guarda en el congelador y se usa calzándolo en la botella de cerveza, enfriándola en minutos.

DE | Der Aktiv Bierkühler kann in der Tiefkühltruhe aufbewahrt und zum Kühlen von Bierflaschen in wenigen Minuten verwendet werden.





76010602

## SWIRLING CARAFE

EN | The Swirling Carafe is a spinning centerpiece that allows wine to breathe in a special and elegant way. Swirling helps releasing the different aromas in wine for an improved taste experience. The crystal glass carafe and cork base gives a premium appearance.

FR | La Carafe tourbillonnante permet d'aérer votre vin de façon élégante. Tourbillonner aide à libérer les différents arômes dans le vin et vous donnera une meilleure expérience gustative. La carafe en cristal et le support en liège donne un aspect chaleureux.

ES | La Garrafa Giratoria consta de una pieza central giratoria que permite respirar al vino de una forma especial y elegante. Dar vueltas ayuda a liberar los diferentes aromas del vino mejorando la experiencia de degustar. La garrafa de cristal y la base de corcho le da una apariencia superior.

DE | Der Schwingdekanter ist ein sich drehendes Herzstück, mit dem Wein auf besondere und elegante Weise atmen kann. Durch das Verwirbeln werden die verschiedenen Aromen im Wein freigesetzt, um das Geschmackserlebnis zu verbessern. Die Kristallglaskaraffe und der Korkboden sorgen für ein erstklassiges Erscheinungsbild.



1886461

## GLASS MARKERS CLASSIC

EN | The Glass Markers Classic attach to any smooth surface with a suction cup. Differentiate wine glasses with 8 individual colors.

FR | Le lot de 8 marque-verres Classic, idéal pour personnaliser vos verres. Ils adhèrent à toute surface lisse du verre.

ES | Los marcadores de copas clásicos se adhieren a cualquier superficie lisa con una ventosa. Diferencia las copas de vino con 8 colores distintos.

DE | Die Glasmarker Klassik lassen sich mit einem Saugnapf auf fast jeder glatten Oberfläche befestigen. Differenziere Weingläser mit 8 individuellen Farben.



18540612

## WINE SERVER CRYSTAL

EN | The Wine Server Crystal guarantees pouring without dripping. The pouring edge catches drops and flows them back into the bottle.

FR | L'anti-goutte pour les bouteilles de vin vous permettant de servir parfaitement le vin sans gouter et qui récupère l'excès de vin dans la bouteille.

ES | El servidor de vino cristal garantiza verter el vino sin goteo. El doble borde recoge las gotas y las introduce de nuevo en la botella.

DE | Der Weinausgießer garantiert tropffreies Ausgießen. Die Ausgießkante fängt die Tropfen auf und lässt sie in die Flasche zurückfließen.

1886060

## GLASS MARKERS PARTY PEOPLE

EN | The Glass Markers Party People are shaped in 12 colorful characters. The unique markers attach to any smooth surface with a suction cup.

FR | Les marque-verres Party People sont 12 petites ventouses humidifiées, elles adhèrent à la paroi lisse du verre.

ES | Los marcadores de copas Party People son personajes moldeados en 12 colores. Los marcadores únicos se adhieren a cualquier superficie lisa con una ventosa.

DE | Die Glasmarker Party People bestehen aus 12 farbenfrohen Figuren. Die einzigartigen Markierungen können mit Hilfe des Saugnapfs an fast jeder glatten Oberfläche befestigt werden.





**Using the Aerator**

By pouring your wine with the Aerator, you're able to aerate your wine directly from the bottle. Thanks to the unique shape of the Aerator, the wine swirls through the air chambers to absorb extra oxygen while pouring.

**Using the Slow Wine Pourer**

By pouring your wine with the Slow Wine Pourer, you're able to serve your wine with minimum oxygen contact. The patented design guides the wine from the bottle into the glass through an air consealed system.



1854660

**WINE AERATOR**

EN | The Wine Aerator enriches the taste of wine by adding extra oxygen. Aerates the wine directly from the bottle and removes the need to decant.

FR | L'Aérateur à Vin est un appareil destiné à oxygéner le vin, pas besoin de décantier. Par son design, le vin est immédiatement aéré.

ES | El aireador de vino enriquece el sabor del vino añadiendo oxígeno extra. Airea el vino directamente desde la botella y elimina la necesidad de decantarlo.

DE | Der Weinbelüfter bereichert den Geschmack des Weins durch Zugabe von zusätzlichem Sauerstoff. Er belüftet den Wein direkt aus der Flasche und macht das Dekantieren überflüssig.



18570616

**SLOW WINE POURER GIFT BOX**

EN | Creates a unique flavor sensation by pouring wine with minimum oxygen contact. Suitable for all still wines.

FR | Crée une sensation de saveur unique en versant du vin avec un contact minimal avec l'oxygène. Convient à tous les vins.

ES | Crea una sensación de sabor única sirviendo el vino con el mínimo contacto con el oxígeno. Apto para todos los vinos sin gas.

DE | Erzeugt ein einzigartiges Geschmackserlebnis, indem Wein mit minimalem Sauerstoffkontakt eingeschenkt wird. Geeignet für alle stillen Weine.

06492616

**WINE SAVER STAINLESS STEEL**

EN | The Wine Saver preserves your wine under vacuum. Creates a vacuum to slow down the oxidation process and preserve wine for a longer period of time. Makes a "click" sound when optimum vacuum is reached. This premium edition in luxury gift box is the perfect gift.

FR | La pompe préserve le vin sous vide. La mise sous vide ralentit le processus d'oxydation et conserve le vin plus longtemps. Un « click » sonore retentit indiquant que le niveau de vide nécessaire est atteint. Une édition premium en coffret cadeau.

ES | La bomba de vacío conserva su vino al vacío. Hace el vacío para reducir el proceso de oxidación y preserva el vino por un mayor periodo de tiempo. Hace un sonido "clic" cuando se alcanza el vacío óptimo. Esta edición superior en estuche de lujo es el regalo perfecto.

DE | Die Weinpumpe bewahrt Ihren Wein unter Vakuum auf. Sie erzeugt ein Vakuum, um den Oxidationsprozess zu verlangsamen und den Wein länger haltbar zu machen. Die Weinpumpe gibt ein Klickgeräusch von sich, wenn das optimale Vakuum erreicht ist. Diese Premium Edition in der Luxus-Geschenkbbox ist das perfekte Geschenk.



WINE SAVER WHITE  
08532606 (1 Pump)  
08542606 (1 Pump, 1 Stopper)  
09812606 (1 Pump, 2 Stoppers)

WINE SAVER BLACK  
0854460 (1 Pump, 1 Stopper)  
09814606 (1 Pump, 2 Stoppers)  
09824606 (1 Pump, 4 Stoppers)

WINE SAVER CONCERTO  
09872606 (1 Pump, 1 Stopper)  
09875606 (1 Pump, 2 Stoppers)

WINE SAVER STAINLESS STEEL  
06492606 (1 Pump, 2 Stoppers)

## WINE SAVER

EN | The Wine Saver pump extracts the air from opened bottles and reseals it with a reusable rubber stopper. The vacuum slows down the oxidation process to store wine for a longer period of time. Place the vacuum stopper in the bottle and pump until it makes a "click" sound.

- Wine Saver originates from the first version ever created in 1986
- Wine Saver Concerto is designed with an ergonomic and stylish grip
- Wine Saver Stainless Steel is the premium edition of the original

FR | La pompe aspire l'air restant de la bouteille entamée et vous fermez hermétiquement avec le bouchon réutilisable. La mise sous vide ralentit le processus d'oxydation qui permet de savourer votre vin à une date ultérieure. Un « click » sonore retentit indiquant que le niveau de vide nécessaire est atteint.

- La pompe provient de la 1ère version créée en 1986
- La pompe Concerto est conçu avec une poignée ergonomique et élégante
- La pompe en acier brossé est l'édition premium de l'original

ES | La bomba de vacío para vino saca el aire de las botellas abiertas y la sella con un tapón reutilizable de goma. El vacío ralentiza el proceso de oxidación para mantener el vino por más tiempo. Ponga el tapón en la botella y bombee hasta que oiga un "clic".

- El conservador de vino nace de la primera versión originalmente creada en 1986
- El conservador de vino Concerto está diseñado con un ergonómico y estiloso agarre
- El conservador de vino de acero inoxidable es la edición superior del original

DE | Die Weinpumpe saugt die Luft aus den geöffneten Flaschen ab und verschließt sie mit einem wiederverwendbaren Stopfen. Das Vakuum verlangsamt den Oxidationsprozess, um Wein für einen längeren Zeitraum zu lagern. Setzen Sie den Vakuumstopfen auf die Flasche und pumpen Sie, bis ein Klickgeräusch zu hören ist.

- Die erste Version der Weinpumpe wurde 1986 erstellt
- Die Weinpumpe Concerto wurde mit einem ergonomischen und eleganten Griff entworfen
- Die Weinpumpe Edelstahl ist die Premium Edition des Originals

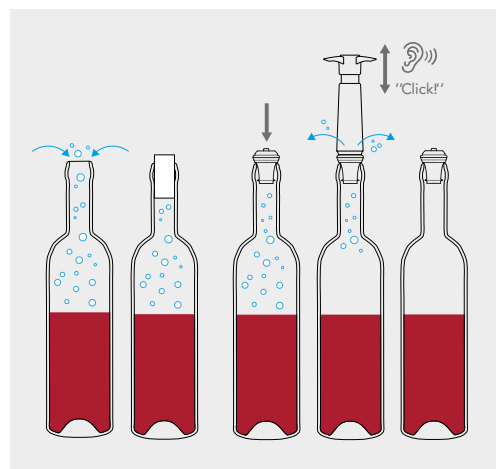

### Regular sealing

When an opened bottle is resealed with a regular stopper, oxygen is locked inside the bottle. The oxygen in this bottle will start an oxidation process affecting the taste of the wine.

### Vacuum sealing

With vacuum technology, the air (with oxygen) will be extracted from the bottle so the wine can be preserved for a longer period of time. Follow these simple steps to enjoy a fresh wine at a later moment.

1. Place the Vacuum Stopper on an opened bottle.
2. Use the Wine Saver pump to extract the air from the bottle.
3. When optimum vacuum is reached, you will hear a "click"



06824606



SET OF 2 08840612 SET OF 6 0886360 SET OF 10 0883060



SET OF 3 08850606

## VACUUM WINE STOPPER

EN | The Vacuum Wine Stoppers preserve opened wine bottles under vacuum with the regular Wine Savers. Reusable and dishwasher safe.

FR | Le bouchon conserve le vin d'une bouteille entamée sous vide en utilisant nos pompes à vide. Réutilisable et passe au lave-vaisselle.

ES | Tem suntent maxim dolendit quam fugitatis quibus simint aut la que que sus sandiae sequid mod quas volorporum alitiam.

DE | Die Stopfen für die Weinpumpe konservieren geöffnete Weinflaschen unter Vakuum mit den regulären Weinpumpen. Sie sind wiederverwendbar und spülmaschinenfest.

## WINE SAVER & SERVER

EN | The Wine Saver & Server preserves your wine under vacuum. The Server & Stopper combines vacuum sealing and drip-free pouring.

FR | La pompe serveur & anti-goutte le vin sous vide. Bouchon-verseur combine le scellage sous vide avec le versement anti-goutte.

ES | El conservador y servidor conserva su vino al vacío. Servidor y tapón actúa como sellador y servidor anti goteo.

DE | Die Weinpumpe mit Ausgießer bewahrt Ihren Wein unter Vakuum auf. Ausgießer & Verschluss kombiniert Vakuum Aufbewahrung und tropffreies Gießen.

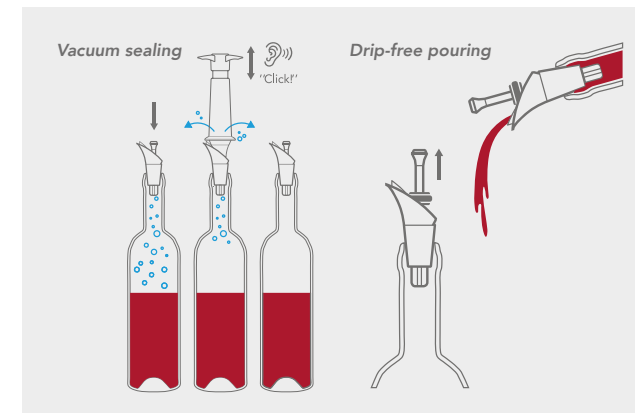

06504606

## WINE SERVER & STOPPER

EN | The Wine Server & Stopper pours wine without dripping. Preserve wine under vacuum in combination with the Wine Saver & Server.

FR | Servez votre vin sans goutter. Conserve le vin en utilisant la pompe Wine Saver & Server.

ES | El tapón y escanciador de vino sirve el vino sin gotear. Mantiene el vino al vacío combinándolo con el conservador y servidor de vino.

DE | Der Ausgießer mit Verschluss gießt Wein ein, ohne zu tropfen. Bewahren Sie Wein unter Vakuum in Kombination mit der dafür entwickelten Weinpumpe auf.





08874606

## BOTTLE STOPPER

EN | The Bottle Stopper seals opened wine bottles. Easy to unplug by pulling the ring on top.

FR | Un bouchon pour reboucher une bouteille de vin après son ouverture. Facile à retirer par l'anneau.

ES | El tapón para botella sella las botellas de vino una vez abiertas.

DE | Die Flaschenstopfen verschließen geöffnete Weinflaschen. Durch einfaches Ziehen an dem Ring an der Oberseite des Stopfens zieht man diesen wieder aus der Flasche.



18804606

## CHAMPAGNE SAVER & SERVER

EN | The Champagne Saver & Server is a combined solution to serve without dripping and preserve the bubbling freshness of champagne.

FR | Le Champagne Saver préserve le pétillant naturel du champagne et minimise son oxydation. Conçu avec un système anti-goutte.

ES | El servidor y conservador de cava es una solución combinada para servir sin gotear y conservar la burbujeante fresca del cava.

DE | Der Champagnerverschluss und -ausgießer ist eine kombinierte Lösung, die tropffrei serviert und die sprudelnde Frische von Champagner bewahrt.



18813606

## CHAMPAGNE STOPPER

EN | The Champagne Stopper keeps champagne fresh by preserving the bubbles. Reseal and reopen champagne bottles easily.

FR | Ce bouchon préserve le pétillant naturel du champagne. Facilement à fermer et ouvrir.

ES | El tapón de cava mantiene el cava fresco, preservando las burbujas. Vuelve a sellar y reabrir las botellas de cava fácilmente.

DE | Der Champagnerverschluss hält den Champagner frisch, indem er die Kohlensäure konserviert. Champagnerflaschen einfach wieder verschließen und wieder öffnen.



18603606

## WHISKEY STONES

EN | The Whiskey Stones chill whiskey while preserving its flavor. Store the 4 stainless steel cubes in the freezer and refrain from adding traditional ice cubes.

FR | Les Pierres à Whisky sont conservées au congélateur et seront ajoutées dans le verre à whisky pour les rafraîchir au lieu d'utiliser des glaçons.

ES | Los cubitos para whiskey enfrían el whiskey conservando su sabor. Guarde los 4 cubitos de acero inoxidable en el congelador y absténgase de añadir los tradicionales cubitos de hielo.

DE | Die Whisky Kühlsteine kühlen den Whisky und behalten dabei seinen Geschmack. Bewahren Sie die 4 Edelstahlwürfel im Gefrierschrank auf. Herkömmliche Eiswürfel entfallen dadurch und verwässern nicht länger den Whisky.

## COCKTAIL ESSENTIALS

EN | The Cocktail Essential tools provide everything to mix professional cocktails. Suitable for home and professional use. The Double Jigger has a capacity of 15ml and 30 ml (0.5 fl. Oz. and 1 fl. Oz.). The Muddler bruises or grinds ingredients. The Bar spoon, Shaker and Strainer are perfect for mixing and serving the cocktails.

FR | Le coffret cocktail contient tous les outils nécessaires pour préparer un cocktail professionnel. Pratique à la maison et pour les professionnels. Le double doseur a une capacité de 15ml et 30ml (0.5 fl. Oz. Et 1 fl. Oz.). Avec le pilon vous pouvez concasser ou presser des ingrédients, la cuillère, le shaker et passoire sont parfait pour préparer vos cocktails.

ES | Los artículos del Cocktail Essential le proporcionan todo para hacer cócteles profesionales. Apto tanto para uso profesional como casero. El vaso de medir doble tiene capacidad de 15 y 30 ml. El mezclador machaca y tritura los ingredientes. La cuchara de bar y coctelera con filtro son perfectas para mezclar y servir los cócteles.

DE | Die Cocktail Accessoires bieten alles, um professionelle Cocktails zu mixen. Geeignet für den privaten und professionellen Gebrauch. Das Barmaß hat ein Fassungsvermögen von 15 ml und 30 ml (0,5 fl. Oz. Und 1 fl. oz.). Der Stößel zerquetscht oder zermahlt Zutaten. Der Barlöffel, der Shaker und das Sieb eignen sich perfekt zum Mixen und Servieren der Cocktails.



78423606

### COCKTAIL SHAKER



78323606

### DOUBLE JIGGER



78633606

### HIP FLASK & FUNNEL



78623606

### BAR SPOON



78545606

### COCKTAIL MUDDLER



78525606

### COCKTAIL STRAINER

NEW ARRIVAL



7889361

## COCKTAIL SET PLUS

EN | Complete collection of 7 bar tools to create your favourite cocktails in style. This set contains a Cocktail Shaker (550 ml), Double Jigger, Muddler, Strainer, Fine Sieve, Bottle Pourer and Bar Spoon.

FR | Collection complète de 7 outils de bar pour créer vos cocktails préférés avec style. Ce set contient un shaker à cocktail (550 ml), un doseur, un pilon, un strainer, une passoire fine, un bec verseur et une cuillère à mélange.

ES | Colección completa de 7 accesorios de coctelería para preparar sus cócteles favoritos con estilo. Este set incluye coctelera (550 ml), medidor doble, mano de mortero, colador de gusanillo, colador fino, vertedor y cuchara.

DE | Komplette Kollektion von 7 Barutensilien, um Ihre Lieblingscocktails stilvoll zu kreieren. Dieses Set enthält einen Cocktail-Shaker (550 ml), ein Barmaß, einen Stößel, ein Sieb, ein Feinsieb, einen Flaschenausgießer und einen Barlöffel.

7889362

## COCKTAIL SET BASIC

EN | The perfect starter kit including a Cocktail Shaker (350 ml), Double Jigger and Muddler to create your favourite drinks in style.

FR | Le kit de démarrage idéal avec un Shaker à Cocktail (350 ml), un Doseur et un Pilon pour créer vos boissons préférées avec style.

ES | El kit de coctelería para principiantes ideal con Coctelera (350 ml), Medidor doble y Mano de mortero para preparar sus bebidas favoritas con estilo.

DE | Das perfekte Einsteiger-Set mit Cocktail-Shaker (350 ml), Barmaß und Stöße um Ihre Lieblingsdrinks stilvoll zubereiten können.







4874360

## PINEAPPLE SLICER & WEDGER STAINLESS STEEL

EN | The Pineapple Slicer & Wedger creates fresh pineapple rings or chunks in no time. The stainless steel blades easily cut through the fruit. Twist the Pineapple Slicer into the fruit to create fresh pineapple rings. Cut the pineapple rings in equal parts with the included wedger.

FR | Le découpe-ananas & découpe-morceaux, évide, épluche et tranche un ananas frais. La lame de acier brossé coupe très facilement le fruit. Il fonctionne comme un tire-bouchon et découpe la chair du fruit en rondelles. Avec le découpe-morceaux séparé, vous coupez en morceaux égaux.

ES | El cortapiñas y troceador crea anillos o porciones de piña fresca en cuestión de segundos. Los filos de acero inoxidable cortan fácilmente la fruta. Gire el cortapiñas dentro de la fruta para crear anillos de piña fresca. Corte los anillos en partes iguales con el troceador que va incluido.

DE | Der Ananasschneider & Achtelteiler kreiert in kürzester Zeit frische Ananasringe oder -stücke. Die Edelstahlklingen schneiden leicht durch die Früchte. Drehen Sie den Ananasschneider in die Frucht, um frische Ananasringe zu erhalten. Schneiden Sie die Ananasringe zu gleichen Teilen mit dem mitgelieferten Teiler.



4852266

## PINEAPPLE SLICER

EN | The Pineapple Slicer creates fresh pineapple rings in no time. An easy tool for a delicious fruit.

FR | Le découpe-ananas, évide, épluche et tranche un ananas frais. Un outil simple pour un fruit délicieux.

ES | El cortapiñas crea anillos de piña fresca en cuestión de segundos. Un utensilio sencillo para una fruta deliciosa.

DE | Der Ananasschneider kreiert in kürzester Zeit frische Ananasringe. Ein einfaches Werkzeug für eine köstliche Frucht.



4863260

## PINEAPPLE SLICER & WEDGER

EN | The Pineapple Slicer & Wedger creates fresh pineapple rings or chunks in no time. Twist the Pineapple Slicer for rings and cut these into equal parts with the included wedger.

FR | Le découpe-ananas + découpe-morceaux, évide, épluche et tranche un ananas frais. Avec le découpe-morceaux séparé, vous coupez en morceaux égaux.

ES | El cortapiñas y troceador crea anillos y porciones de fruta fresca en cuestión de segundos. Gire el cortapiñas para hacer anillos y córtelos en partes iguales con el troceador que va incluido.

DE | Der Ananasschneider & Achtelteiler kreiert in kürzester Zeit frische Ananasringe oder -stücke. Drehen Sie den Ananasschneider für Ringe und schneiden Sie diese mit dem mitgelieferten Keil in gleiche Teile.

### How to use the Pineapple Slicer & Wedger

Create fresh pineapple slices in no time with the Pineapple Slicer. Cut the pineapple slices into equal parts with the included wedger.

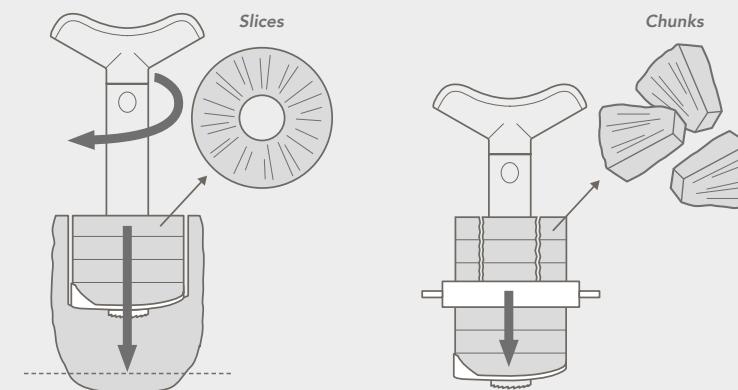



46703606

## UTENSIL REST

EN | The Utensil Rest keeps your countertop clean during cooking. Multiple notches for various kitchen tools. Heat resistant and dishwasher safe.

FR | Gardez votre plan de travail propre pendant que vous cuisinez avec le Pose Ustensiles. Encoches pour insérer jusqu'à 4 ustensiles de cuisine. Résistance à la chaleur et passe au lave-vaisselle.

ES | El descanso utensilios mantiene su encimera limpia mientras cocina. Varias muescas para diferentes utensilios de cocina.

DE | Die Utensilienablage hält Ihre Arbeitsplatte während des Kochens sauber. Mehrere Kerben für verschiedene Küchengeräte. Hitzebeständig und spülmaschinenfest.



28704606

## VACUUM CONTAINER

EN | The Vacuum Container is a 2-in-1 design for vacuum storage and instant marinating. With the included Vacuum Pump you can extract the air to keep your food fresh for longer or marinate meat in no time.

FR | Système de conservation sous vide 2-en-1 pour conserver et mariner. Le fait de pomper l'air du récipient permet de réaliser la mise sous vide pour garder les aliments frais plus longtemps ou pour mariner de la viande en peu de temps.

ES | El recipiente al vacío es un diseño 2 en 1 para conservar al vacío y marinar al instante. Con la bomba de vacío incluida puedes extraer el aire para mantener tus alimentos frescos durante más tiempo o marinar la carne en cuestión de segundos.

DE | Der Vakuumbehälter ist ein 2-in-1-Design zur Vakuumlagerung und sofortigem marinieren. Die mitgelieferte Vakuumpumpe saugt die Luft ab, um Ihre Lebensmittel länger frisch zu halten oder Fleisch in kürzester Zeit marinieren.



3548360

### The special product features of the Cool Plate

Store the included cooling element in the freezer. Place the frozen element beneath the stainless steel plate to keep your food chilled. The lid covers your food to protect it from flies or dust.

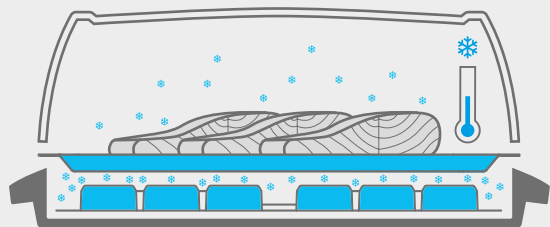

## COOL PLATE

EN | The Cool Plate keeps your food fresh for longer outside the fridge. Suitable for meat, fish, cheese, appetizers and cake. Store cooling element in the freezer.

FR | Le plateau rafraîchisseur conserve au frais vos aliments sortis du frigo. Idéal pour la viande, le poisson, le fromage ou les pâtisseries. Conserver le élément refroidisseur dans le congélateur.

ES | La bandeja enfriadora mantiene su comida fresca fuera de la nevera por más tiempo. Apta para carne, pescado, queso, aperitivos y tartas. Guarde el elemento enfriador en el congelador.

DE | Die Kühlplatte hält Ihre Lebensmittel außerhalb des Kühlschranks länger frisch. Geeignet für Fleisch, Fisch, Käse, Vorspeisen und Kuchen. Kühlelement im Gefrierschrank aufbewahren.



GIFT SETS

## GIFT SETS

EN | These Wine Sets vary from starter sets to accessories for the professional. Most sets contain tools to open, chill, serve and preserve your wine. Perfect gifts for wine enthusiasts or to treat yourself with a complete wine accessory collection.

FR | Ces coffrets vari de débutants jusqu'au professionnels. La plupart des coffrets contient des outils pour ouvrir, refroidir, servir et conserver votre vin. Cadeau idéal pour les amateurs de vin ou pour compléter vos accessoires de vin.

ES | Los juegos de vino varían desde los sets para principiantes a los accesorios para profesionales. La mayoría se componen de artículos para abrir, enfriar, servir y conservar su vino. Regalos ideales para los entusiastas del vino o hacerte un regalo a ti mismo, con una colección completa de accesorios de vino.

DE | Diese Weinsets variieren von Startersets bis hin zu Zubehör für den Profi. Die meisten Sets enthalten Accessoires zum Öffnen, Kühlen, Servieren und Aufbewahren Ihres Weins. Perfekte Geschenke für Weinliebhaber oder zum Verwöhnen mit einer kompletten Weinaccessoiresammlung.





09876606

### WINE SAVER CONCERTO GIFT SET

- 1 x Wine Saver Concerto
- 3 x Vacuum Wine Stopper
- 1 x Wine Server Crystal



3890160

### WINE SET CLASSIC

- 1 x Double Hinged Corkscrew
- 1 x Active Cooler Wine Black
- 1 x Wine Server Crystal
- 1 x Bottle Stopper



3890660

### WINE SET ELEGANT

- 1 x Corkscrew Twister
- 1 x Active Cooler Elegant Black
- 1 x Wine Server Crystal
- 1 x Wine Saver Black
- 1 x Vacuum Wine Stopper



3890460

### WINE SET PREMIUM

- 1 x Single Pull Corkscrew
- 1 x Active Cooler Wine Black
- 1 x Wine Saver & Server
- 1 x Wine Server & Stopper



3890260

### WINE SET ORIGINAL

- 1 x Double Hinged Corkscrew
- 1 x Active Cooler Wine Black
- 1 x Wine Server Crystal
- 1 x Wine Saver Black
- 1 x Vacuum Wine Stopper



3890360

### WINE SET ORIGINAL PLUS

- 1 x Foil Cutter
- 1 x Corkscrew Twister
- 1 x Active Cooler Wine Black
- 1 x Wine Server Crystal
- 1 x Wine Saver Concerto
- 1 x Vacuum Wine Stopper



68897606

### WINE ACCESSORY SET

- 1 x Double Hinged Corkscrew
- 1 x Active Cooler Wine Black
- 1 x Wine Server Crystal
- 1 x Wine Saver Black
- 2 x Vacuum Wine Stopper



38899606

### CHAMPAGNE ACCESSORY SET

- 1 x Champagne Opener
- 1 x Champagne Saver & Server
- 1 x Active Cooler Champagne Bottles



# Product Specifications



Article number:  
EAN Code:  
UPC Code:

68854606  
8714793 688544  
084256 688540

Units/Carton:  
Gross weight:  
(outercase)  
Dimensions:  
(outercase)

6  
1,0 kg  
2.3 lbs  
28,4 x 10,1 x 13,0 cm  
11.2 x 4.0 x 5.1 inch



Single Pull Corkscrew Black, Box

68514606  
8714793 685147  
084256 685143

6  
0,6 kg  
1.3 lbs  
20,0 x 10,6 x 11,0 cm  
7.9 x 4.2 x 4.3 inch



Double Hinged Corkscrew Black, Card

68504606  
8714793 685048  
084256 685044

6  
0,45 kg  
0.99 lbs  
19,8 x 9,2 x 12,2 cm  
7.8 x 3.6 x 4.8 inch



Waiter's Corkscrew Black, Card



Corkscrew Twister Black, Box

68814606  
8714793 688148  
084256 688144

6  
0,8 kg  
1.7 lbs  
42,2 x 16,6 x 10,2 cm  
16.6 x 6.5 x 4.0 inch



Winged Corkscrew Silver, Box

Article number:  
EAN Code:  
UPC Code:

68423606  
8714793 684232  
084256 684238

Units/Carton:  
Gross weight:  
(outercase)  
Dimensions:  
(outercase)

6  
1,7 kg  
3.7 lbs  
42,0 x 14,2 x 10,0 cm  
16.5 x 5.6 x 3.9 inch



Lever Corkscrew Horizontal Black, Box

66514606  
8714793 665149  
084256 665145

6  
4,0 kg  
8.8 lbs  
34,6 x 20,8 x 17,0 cm  
13.6 x 8.2 x 6.7 inch



Cork Puller, Card

68405606  
8714793 684058  
084256 684054

6  
0,5 kg  
1.0 lbs  
20,0 x 10,6 x 11,0 cm  
7.9 x 4.2 x 4.3 inch



Foil Cutter (4 knives) Black, Blister

68544606  
8714793 685444  
084256 685440

6  
0,2 kg  
0.5 lbs  
22,6 x 18,6 x 11,9 cm  
6.6 x 6.0 x 4.7 inch



Champagne Opener Card

Article number:  
EAN Code:  
UPC Code:

68615606  
8714793 686151  
084256 686157

Units/Carton:  
Gross weight:  
(outercase)  
Dimensions:  
(outercase)

6  
0,7 kg  
1.5 lbs  
37,6 x 16,8 x 7,2 cm  
14.8 x 6.6 x 2.8 inch



Champagne Bottle Opener Box

68625606  
8714793 686250  
084256 686256

6  
1,5 kg  
3.3 lbs  
32,8 x 12,6 x 8,8 cm  
12.9 x 5.0 x 3.5 inch



Flexible Wine Cooler Artico Black, Box

38864606  
8714793 388642  
084256 388648

6  
2,96 kg  
6.52 lbs  
44,0 x 18,5 x 17,5 cm  
17.3 x 7.3 x 6.9 Inch



Active Cooler Wine Black Sleeve

38804606  
8714793 388048  
084256 308042

6  
2,0 kg  
4.4 lbs  
37,0 x 11,3 x 16,1 cm  
14.6 x 4.4 x 6.3 inch





**Active Cooler Wine Platinum Sleeve**

Article number: 38805626  
 EAN Code: 8714793 308053  
 UPC Code: 084256 308059

Units/Carton: 6  
 Gross weight: 2,0 kg  
 (outercase) 4.4 lbs  
 Dimensions: 37,0 x 11,3 x 16,1 cm  
 (outercase) 14.6 x 4.4 x 6.3 inch



**Active Cooler Wine Grapes Sleeve**

Article number: 38814606  
 EAN Code: 8714793 388147  
 UPC Code: 084256 388143

Units/Carton: 6  
 Gross weight: 2,0 kg  
 (outercase) 4.4 lbs  
 Dimensions: 37,0 x 11,3 x 16,1 cm  
 (outercase) 14.6 x 4.4 x 6.3 inch



**Active Cooler Wine Silver Sleeve**

Article number: 38803606  
 EAN Code: 8714793 388031  
 UPC Code: 084256 388037

Units/Carton: 6  
 Gross weight: 2,0 kg  
 (outercase) 4.4 lbs  
 Dimensions: 37,0 x 11,3 x 16,1 cm  
 (outercase) 14.6 x 4.4 x 6.3 inch



**Active Cooler Champagne Black Sleeve**

Article number: 38856606  
 EAN Code: 8714793 388567  
 UPC Code: 084256 388563

Units/Carton: 6  
 Gross weight: 2,3 kg  
 (outercase) 5.1 lbs  
 Dimensions: 44,9 x 10,6 x 17,5 cm  
 (outercase) 17.7 x 4.2 x 6.9 inch



**Active Cooler Champagne Elegant Stainless Steel, Box**

Article number: 3647360  
 EAN Code: 8714793 364738  
 UPC Code: 084256 364734

Units/Carton: 6  
 Gross weight: 7,4 kg  
 (outercase) 16.3 lbs  
 Dimensions: 56,6 x 39,1 x 24,0 cm  
 (outercase) 22.3 x 15.4 x 9.5 inch



**Active Cooling Carafe Black, Box**

Article number: 3645460  
 EAN Code: 8714793 364547  
 UPC Code: 084256 364543

Units/Carton: 6  
 Gross weight: 9,3 kg  
 (outercase) 20.5 lbs  
 Dimensions: 47,0 x 31,5 x 31,8 cm  
 (outercase) 18.5 x 12.4 x 12.5 inch

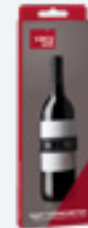

**Snap Thermometer (CEL) Grey, Box**

Article number: 3630360  
 EAN Code: 8714793 363038  
 UPC Code: 084256 363034

Units/Carton: 6  
 Gross weight: 0,4 kg  
 (outercase) 0.8 lbs  
 Dimensions: 27,0 x 8,5 x 9,7 cm  
 (outercase) 10.6 x 3.4 x 3.8 inch



**Active Cooler Beer Sleeve**

Article number: 38549606  
 EAN Code: 8714793 385498  
 UPC Code: 084256 385494

Units/Carton: 6  
 Gross weight: 1,3 kg  
 (outercase) 2.9 lbs  
 Dimensions: 28,4 x 10,1 x 13 cm  
 (outercase) 11.2 x 4.0 x 5.1 inch



**Active Cooler Champagne Bottles Sleeve**

Article number: 38854606  
 EAN Code: 8714793 388543  
 UPC Code: 084256 388549

Units/Carton: 6  
 Gross weight: 2,3 kg  
 (outercase) 5.1 lbs  
 Dimensions: 44,9 x 10,6 x 17,5 cm  
 (outercase) 17.7 x 4.2 x 6.9 inch



**Active Cooler Champagne Platinum Sleeve**

Article number: 38855626  
 EAN Code: 8714793 388529  
 UPC Code: 084256 388525

Units/Carton: 6  
 Gross weight: 2,3 kg  
 (outercase) 5.1 lbs  
 Dimensions: 44,9 x 10,6 x 17,5 cm  
 (outercase) 17.7 x 4.2 x 6.9 inch



**Active Cooler Wine & Champagne, 2 pcs, Box**

Article number: 3887560  
 EAN Code: 8714793 388758  
 UPC Code: 084256 388754

Units/Carton: 6  
 Gross weight: 4,2 kg  
 (outercase) 9.3 lbs  
 Dimensions: 33,0 x 21,4 x 23,8 cm  
 (outercase) 13.0 x 8.4 x 9.4 inch



**Active Cooler Wine Botanical Limited Edition, Box**

Article number: 38829606  
 EAN Code: 8714793 388291  
 UPC Code: 084256 388297

Units/Carton: 6  
 Gross weight: 1,99 kg  
 (outercase) 4.39 lbs  
 Dimensions: 37,0 x 11,3 x 16,1 cm  
 (outercase) 14.6 x 4.4 x 6.3 inch



**Swirling Carafe (Crystal Glass), Box**

Article number: 76010602  
 EAN Code: 8714793 760103  
 UPC Code: 084256 760109

Units/Carton: 2  
 Gross weight: 3,42 kg  
 (outercase) 7.54 lbs  
 Dimensions: 47,2 x 29,1 x 27,5 cm  
 (outercase) 18.6 x 11.5 x 10.8 Inch



**Glass Markers Classic 8 pcs, Box**

Article number: 1886461  
 EAN Code: 8714793 108646  
 UPC Code: 084256 108642

Units/Carton: 12  
 Gross weight: 0,8 kg  
 (outercase) 1.9 lbs  
 Dimensions: 21,1 x 15,3 x 21,7 cm  
 (outercase) 8.3 x 6.0 x 8.5 inch



**Glass Markers Party People 12 pcs, Box**

Article number: 1886060  
 EAN Code: 8714793 188600  
 UPC Code: 084256 188606

Units/Carton: 12  
 Gross weight: 0,7 kg  
 (outercase) 1.6 lbs  
 Dimensions: 21,1 x 15,3 x 21,7 cm  
 (outercase) 8.3 x 6.0 x 8.5 inch



**Wine Server Crystal Black 2 pcs, Blister**

Article number: 18540612  
 EAN Code: 8714793 185401  
 UPC Code: 084256 185407

Units/Carton: 12  
 Gross weight: 0,4 kg  
 (outercase) 0.9 lbs  
 Dimensions: 22,6 x 18,6 x 11,9 cm  
 (outercase) 8.9 x 7.3 x 4.7 inch



**Active Cooler Wine Marble Limited Edition, Box**

Article number: 38829616  
 EAN Code: 8714793 388314  
 UPC Code: 084256 388310

Units/Carton: 6  
 Gross weight: 1,99 kg  
 (outercase) 4.39 lbs  
 Dimensions: 37,0 x 11,3 x 16,1 cm  
 (outercase) 14.6 x 4.4 x 6.3 inch



**Active Cooler Wine Royal Gold Limited Edition, Box**

Article number: 38829626  
 EAN Code: 8714793 388963  
 UPC Code: 084256 388969

Units/Carton: 6  
 Gross weight: 1,99 kg  
 (outercase) 4.39 lbs  
 Dimensions: 37,0 x 11,3 x 16,1 cm  
 (outercase) 14.6 x 4.4 x 6.3 inch



**Active Cooler Wine Elegant Black, Box**

Article number: 3649460  
 EAN Code: 8714793 364943  
 UPC Code: 084256 364949

Units/Carton: 6  
 Gross weight: 4,5 kg  
 (outercase) 9.9 lbs  
 Dimensions: 47,6 x 31,5 x 22,6 cm  
 (outercase) 18.7 x 12.4 x 8.9 inch



**Active Cooler Wine Elegant Stainless Steel, Box**

Article number: 3649360  
 EAN Code: 8714793 364936  
 UPC Code: 084256 364932

Units/Carton: 6  
 Gross weight: 6,1 kg  
 (outercase) 13.4 lbs  
 Dimensions: 47,6 x 31,5 x 22,6 cm  
 (outercase) 18.7 x 12.4 x 8.9 inch



**Wine Aerator Grey, Box**

Article number: 1854660  
 EAN Code: 8714793 185463  
 UPC Code: 084256 185469

Units/Carton: 6  
 Gross weight: 0,5 kg  
 (outercase) 1.1 lbs  
 Dimensions: 29,2 x 11,5 x 9,7 cm  
 (outercase) 11.5 x 4.5 x 3.8 inch



**Slow Wine Pourer Gift Box**

Article number: 18570616  
 EAN Code: 8714793 185715  
 UPC Code: 084256 185711

Units/Carton: 6  
 Gross weight: 1,93 kg  
 (outercase) 4.25 lbs  
 Dimensions: 37,8 x 11,8 x 26,2 cm  
 (outercase) 14.9 x 4.6 x 10.3 Inch



**Wine Saver Stainless Steel 1 Pump, 2 Stoppers, Gift Box**

Article number: 06492616  
 EAN Code: 8714793 649262  
 UPC Code: 084256 649268

Units/Carton: 6  
 Gross weight: 1,67 kg  
 (outercase) 3.68 lbs  
 Dimensions: 40,8 x 11,6 x 16,7 cm  
 (outercase) 16,1 x 4,6 x 6,6 Inch



**Wine Saver White 1 Pump, Card**

Article number: 08532606  
 EAN Code: 8714793 085329  
 UPC Code: 084256 085325

Units/Carton: 6  
 Gross weight: 0,6 kg  
 (outercase) 1.3 lbs  
 Dimensions: 22,6 x 18,6 x 11,9 cm  
 (outercase) 8.9 x 7.3 x 4.7 inch



**Wine Saver White**  
1 Pump, 1 Stopper, Blister

Article number: 08542606  
EAN Code: 8714793 085428  
UPC Code: 084256 001288

Units/Carton: 6  
Gross weight: 0,7 kg  
(outercase) 1.6 lbs  
Dimensions: 29,0 x 13,0 x 14,4 cm  
(outercase) 11.4 x 5.1 x 5.7 inch



**Wine Saver Black**  
1 Pump, 1 Stopper, Blister

0854460  
8714793 085442  
084256 085448

6  
0,7 kg  
1.6 lbs  
29,0 x 13,0 x 14,4 cm  
11.4 x 5.1 x 5.7 inch



**Wine Saver White**  
1 Pump, 2 Stoppers, Box

09812606  
8714793 098121  
084256 000182

6  
0,9 kg  
2.0 lbs  
27,7 x 22,8 x 9,8 cm  
10.9 x 9.0 x 3.9 inch

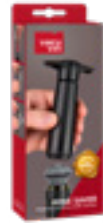

**Wine Saver Black**  
1 Pump, 2 Stoppers, Box

09814606  
8714793 098145  
084256 098141

6  
0,9 kg  
2.0 lbs  
27,7 x 22,8 x 9,8 cm  
10.9 x 9.0 x 3.9 inch



**Vacuum Wine Stopper Grey**  
10 pcs, Bag

Article number: 0883060  
EAN Code: 8714793 088108  
UPC Code: 084256 088104

Units/Carton: 12  
Gross weight: 1,4 kg  
(outercase) 3.1 lbs  
Dimensions: 28 x 27,1 x 10,4 cm  
(outercase) 11 x 10.7 x 4.1 Inch



**Wine Saver Station**  
Stainless Steel

06903601  
8714793 007420  
084256 006122

1  
0,8 kg  
1.8 lbs  
33,6 x 16,7 x 12,5 cm  
13.2 x 6.6 x 4.9 Inch



**Wine Server & Stopper Black**  
2 pcs, Box

06504606  
8714793 065048  
084256 065044

6  
0,3 kg  
0.7 lbs  
20,0 x 12,0 x 9,0 cm  
7.9 x 4.7 x 3.5 inch



**Bottle Stoppers Black**  
2 pcs, Blister

08874606  
8714793 088740  
084256 088746

6  
0,3 kg  
0.7 lbs  
17,1 x 11,4 x 12,2 cm  
6.7 x 4.5 x 4.8 inch



**Wine Saver Black**  
1 pump, 4 stoppers, Box

Article number: 09824606  
EAN Code: 8714793 098244  
UPC Code: 084256 098240

Units/Carton: 6  
Gross weight: 0,98 kg  
(outercase) 2.16 lbs  
Dimensions: 42,2 x 16,6 x 10,2 cm  
(outercase) 16.6 x 6.5 x 4.0 inch



**Wine Saver Concerto Black**  
1 Pump, 1 Stopper, Box

09872606  
8714793 098725  
084256 098721

6  
0,8 kg  
1.8 lbs  
42,2 x 16,6 x 10,2 cm  
16.6 x 6.5 x 4.0 inch



**Wine Saver Concerto Black**  
1 Pump, 2 Stoppers, Box

09875606  
8714793 098756  
084256 098752

6  
0,9 kg  
2.0 lbs  
42,2 x 16,6 x 10,2 cm  
16.6 x 6.5 x 4.0 inch



**Wine Saver Stainless Steel**  
1 Pump, 2 Stoppers, Box

06492606  
8714793 064928  
084256 064924

6  
1,1 kg  
2.4 lbs  
27,7 x 22,8 x 9,8 cm  
10.9 x 9.0 x 3.9 inch



**Champagne Stopper**  
Stainless Steel, Card

Article number: 18813606  
EAN Code: 8714793 188136  
UPC Code: 084256 188132

Units/Carton: 6  
Gross weight: 0,45 kg  
(outercase) 0.99 lbs  
Dimensions: 19,0 x 9,2 x 14,6 cm  
(outercase) 7.5 x 3.6 x 5.7 inch



**Champagne Saver & Server**  
Black, Box

18804606  
8714793 188044  
084256 188040

6  
0,6 kg  
1.3 lbs  
19,6 x 16,8 x 9,8 cm  
7.7 x 6.6 x 3.9 inch



**Whiskey Stones**  
4 pcs, Box

18603606  
8714793 186033  
084256 186039

6  
1,0 kg  
2.1 lbs  
19,6 x 11,0 x 8,2 cm  
7.7 x 11.0 x 8.2 inch



**Cocktail Shaker**  
Stainless Steel, Box

78423606  
8714793 784239  
084256 784235

6  
1,8 kg  
3.9 lbs  
27,4 x 18,4 x 23,6 cm  
10.8 x 7.2 x 9.3 inch



**Wine Saver & Server, Black**  
1 Pump, 1 Server-Stopper, Box

Article number: 06824606  
EAN Code: 8714793 068247  
UPC Code: 084256 068243

Units/Carton: 6  
Gross weight: 0,9 kg  
(outercase) 2.0 lbs  
Dimensions: 42,2 x 16,6 x 10,2 cm  
(outercase) 16.6 x 6.5 x 4.0 inch



**Vacuum Wine Stopper Grey**  
2 pcs, Blister

08840612  
8714793 088405  
084256 002094

12  
0,5 kg  
1.0 lbs  
23,8 x 11,8 x 17,7 cm  
9.3 x 4.6 x 6.9 inch



**Vacuum Wine Stopper**  
Pink/Blue/Purple, 3 pcs, Box

08850606  
8714793 088504  
084256 088500

6  
0,3 kg  
0.7 lbs  
13,6 x 12,9 x 11,7 cm  
5.4 x 5.1 x 4.6 inch



**Vacuum Wine Stopper Grey**  
6 pcs, Blister

0886360  
8714793 088634  
084256 088630

6  
0,6 kg  
1.3 lbs  
29,0 x 13,0 x 14,4 cm  
11.4 x 5.1 x 5.7 inch



**Double Jigger**  
Stainless Steel, Card

Article number: 78323606  
EAN Code: 8714793 783232  
UPC Code: 084256 783238

Units/Carton: 6  
Gross weight: 0,3 kg  
(outercase) 0.6 lbs  
Dimensions: 19,8 x 13 x 10,9 cm  
(outercase) 7.8 x 5.1 x 4.3 inch



**Hip Flask & Funnel**  
Stainless Steel, Box

78633606  
8714793 786332  
084256 786338

6  
1,0 kg  
2.1 lbs  
34,0 x 10,4 x 10,4 cm  
13.4 x 4.1 x 4.1 inch

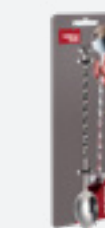

**Bar Spoon**  
Card

78623606  
8714793 786233  
084256 786239

6  
0,6 kg  
1.3 lbs  
38,0 x 16,3 x 6,6 cm  
15.0 x 6.4 x 2.6 inch



**Cocktail Muddler**  
Card

78545606  
8714793 785458  
084256 785454

6  
0,8 kg  
1.8 lbs  
27,2 x 18,4 x 7,9 cm  
10.7 x 7.2 x 3.1 inch





**Cocktail Strainer Card**

Article number: 78525606  
 EAN Code: 8714793 785250  
 UPC Code: 084256 785256

Units/Carton: 6  
 Gross weight: 0,4 kg  
 (outercase) 1.0 lbs  
 Dimensions: 21,4 x 10,8 x 10,9 cm  
 (outercase) 8.4 x 4.3 x 4.3 inch



**Cocktail Set Plus (7 pcs), Box**

7889361  
 8714793 788916  
 084256 788912

6  
 3,4 kg  
 7,5 lbs  
 29,5 x 21,8 x 27,2 cm  
 11,6 x 8,6 x 10.7 Inch



**Cocktail Set Basic (3 pcs), Box**

7889362  
 8714793 788923  
 084256 788929

6  
 2,0 kg  
 4,41 lbs  
 27,8 x 18,8 x 22,2 cm  
 10,9 x 7,4 x 8.7 Inch



**Pineapple Slicer & Wedger Stainless Steel/Yellow, Box**

4874360  
 8714793 487437  
 084256 487433

6  
 1,84 kg  
 4.06 lbs  
 37,3 x 31,6 x 11 cm  
 14,7 x 12.4 x 4.3 inch



**Wine Set Classic (4 pcs), Box**

Article number: 3890160  
 EAN Code: 8714793 389014  
 UPC Code: 084256 889015

Units/Carton: 6  
 Gross weight: 3,27 kg  
 (outercase) 7,21 lbs  
 Dimensions: 35,2 x 28,2 x 23,7 cm  
 (outercase) 13,9 x 11,1 x 9,3 inch



**Wine Set Original (5 pcs), Box**

3890260  
 8714793 389021  
 084256 889022

6  
 4,1 kg  
 9,0 lbs  
 35,2 x 28,2 x 23,7 cm  
 13.8 x 11.1 x 9.3 inch



**Wine Set Original Plus (6 pcs), Box**

3890360  
 8714793 389038  
 084256 889039

6  
 3,65 kg  
 8,06 lbs  
 35,2 x 28,2 x 23,7 cm  
 13,9 x 11,1 x 9,3 inch



**Wine Set Elegant (5 pcs), Box**

3890660  
 8714793 389069  
 084256 389065

6  
 5,4 kg  
 11.9 lbs  
 47,5 x 31,5 x 23,2 cm  
 18.7 x 12.4 x 9.1 inch



**Pineapple Slicer & Wedger White/Yellow, Box**

Article number: 4863260  
 EAN Code: 8714793 486324  
 UPC Code: 084256 486320

Units/Carton: 6  
 Gross weight: 1,12 kg  
 (outercase) 2,47 lbs  
 Dimensions: 43,2 x 26,8 x 17,0 cm  
 (outercase) 17 x 10.6 x 6.7 inch



**Pineapple Slicer Black, Card**

48522606  
 8714793 485228  
 084256 485224

6  
 0,73 kg  
 1.61 lbs  
 27,8 x 14,1 x 27,4 cm  
 10.9 x 5.6 x 10.8 inch



**Utensil Rest Grey, Sleeve**

46703606  
 8714793 467033  
 084256 467039

6  
 0,81 kg  
 1.79 lbs  
 15 x 20,2 x 16,4 cm  
 5.9 x 7.9 x 6.5 inch



**Vacuum Container Black + Pump (1.3 L/ 44 fl.oz), Box**

28704606  
 8714793 287044  
 084256 287040

6  
 3,42 kg  
 7.54 lbs  
 46,4 x 31,0 x 19,6 cm  
 18.3 x 12.2 x 7.7 Inch



**Wine Set Premium (4 pcs), Gift Box**

Article number: 3890460  
 EAN Code: 8714793 389045  
 UPC Code: 084256 889046

Units/Carton: 6  
 Gross weight: 4,85 kg  
 (outercase) 10.69 lbs  
 Dimensions: 35,2 x 28,2 x 23,7 cm  
 (outercase) 13,9 x 11,1 x 9,3 inch



**Wine Saver Concerto Gift Set 1 Pump, 3 Stoppers, 1 Server, Box**

09876606  
 8714793 987661  
 084256 987667

6  
 1,21 kg  
 2.67 lbs  
 36,9 x 20,1 x 15,9 cm  
 14.5 x 7.9 x 6.3 inch



**Champagne Accessory Set (3 pcs), Box**

38899606  
 8714793 388994  
 084256 388990

6  
 3,62 kg  
 7.98 lbs  
 35,2 x 28,2 x 23,7 cm  
 13,9 x 11,1 x 9,3 inch



**Wine Accessory Set (6 pcs), Box**

68897606  
 8714793 688971  
 084256 688977

6  
 4,2 kg  
 9,26 lbs  
 35,2 x 28,2 x 23,7 cm  
 13,9 x 11,1 x 9,3 Inch



**Cool Plate, Box**

Article number: 3548360  
 EAN Code: 8714793 354838  
 UPC Code: 084256 354834

Units/Carton: 3  
 Gross weight: 8,40 kg  
 (outercase) 18.52 lbs  
 Dimensions: 40,1 x 32,6 x 35,9 cm  
 (outercase) 15.8 x 12.8 x 14.1 inch

Article number:  
 EAN Code:  
 UPC Code:

Units/Carton:  
 Gross weight:  
 (outercase)  
 Dimensions:  
 (outercase)



[vacuvin.com](http://vacuvin.com)

#### MAIN OFFICE | EXPORTCENTER



T: +31(0)15 2626926  
F: +31(0)15 2568875  
E: [info@vacuvin.com](mailto:info@vacuvin.com)

#### LOCAL OFFICES



T: +44 1299 250 480  
E: [info.uk@vacuvin.com](mailto:info.uk@vacuvin.com)



T: +33 320 30 63 67  
E: [info.fr@vacuvin.com](mailto:info.fr@vacuvin.com)



T: +1 704 8823521  
F: +1 704 882 4048  
E: [info.us@vacuvin.com](mailto:info.us@vacuvin.com)



T: +49 2324 68 67 60  
F: +49 2324 68 67 679  
E: [info.de@vacuvin.com](mailto:info.de@vacuvin.com)



T: +34 964 62 68 68  
E: [info.es@vacuvin.com](mailto:info.es@vacuvin.com)



T: +32 14 71 90 66  
E: [info.be@vacuvin.com](mailto:info.be@vacuvin.com)





A close-up profile of a woman's face, her eyes closed, with a glass of red wine in the foreground. The lighting is dramatic, highlighting her features against a dark background.

**vacu  
vin**

[vacuvin.com](http://vacuvin.com)

Surprise  
your senses