

LEXON®



WORKBOOK 2023 - 2024



30

30 YEARS OF GOOD DESIGN

30 ANS DE GOOD DESIGN

LEXON®

1991

LEXON is founded in Paris, France

LEXON est créée à Paris, France

MoMA

1999

Tykho radio is selected among MoMA's museum permanent collection

La radio Tykho rejoint la collection permanente du MoMA



2000

LEXON is the first object editor to make the cover of Time Magazine

LEXON est le premier éditeur d'objets à faire la couverture du Time Magazine

BOW GROUP

2018

BOW Group acquires LEXON

Le Groupe BOW fait l'acquisition de LEXON



2023

LEXON wins a record breaking 7 Red Dot Design Awards

LEXON bat son record en remportant 7 Red Dot Design Awards

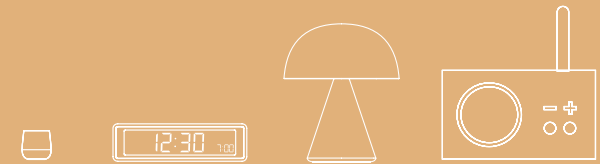

EACH OF OUR ICONIC PRODUCTS HAVE BEEN SOLD AT CHACUN DE NOS PRODUITS ICONIQUES A ÉTÉ VENDU À DES

MILLIONS OF PIECES / DE PIÈCES

+235 INTERNATIONAL AWARDS RÉCOMPENSES INTERNATIONALES

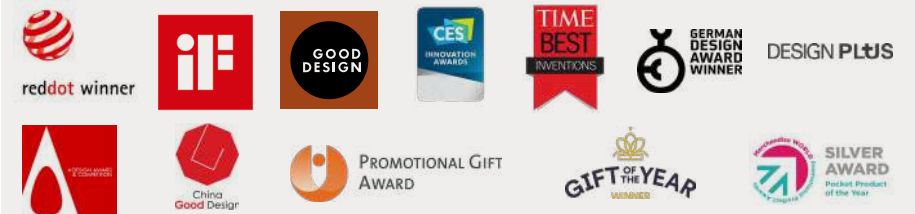

A UNIQUE NETWORK OF DESIGNERS

UN RÉSEAU UNIQUE DE DESIGNERS



LIDIA GOMEZ

Lidia Gómez est une talentueuse designer industrielle espagnole reconnue pour son approche pointue et minimaliste. Son parcours technique a facilité la collaboration avec Lexon pour développer des objets surprenants, mais simples d'utilisation avec un parfait équilibre entre esthétique et fonction. *Lidia Gómez is a talented Spanish Industrial Designer recognized for her sharp and minimalist approach to design. Her tech background has facilitated the collaboration with Lexon to develop surprising, yet consumer-friendly objects with the perfect balance of aesthetics and function.*



NEIL POULTON

Établi depuis 1992 en France, Neil Poulton est mondialement reconnu pour son travail sur les produits électroniques grand public et les luminaires. Ses marques de fabrique sont des formes minimalistes pour un usage quotidien, mêlant simplicité esthétique et innovation technique. Avec Lexon, Neil réinvente les objets de tous les jours en intégrant des performances de haute qualité dans des formes emblématiques. *Established since 1992 in France, Neil Poulton is a globally recognized for his work on consumer electronics products and lighting equipment. His trademarks are minimalist forms for everyday use, blending simple look and technical innovation. Together with Lexon, Neil is reinventing daily objects by embedding high quality performance into iconic shapes.*



STEFANIE KAY

Stéphanie Kay est une jeune designer franco-britannique issue de l'ECAL, la célèbre école Suisse d'art et de design. Son travail a déjà été récompensé par plusieurs prix et sa collaboration avec Lexon consiste à proposer des objets élégants et modernes, avec un accent particulier sur l'expérience utilisateur et les fonctionnalités à valeur ajoutée. *Stéphanie Kay is a French & British young designer from ECAL, the renowned Swiss school of art & design. Her work has already been honored with several awards and her collaboration with Lexon is bringing sleek consumer objects to the market with a special focus on user experience and value-added features.*



ALAIN BERTEAU

Alain Berteau est un architecte, designer et professeur bruxellois. Ses créations sont d'une apparente simplicité tout en offrant un très haut niveau d'innovation fonctionnelle. *Alain Berteau is a Brussels-based architect, product designer and professor. Alain's work is recognized for its combined simplicity and decisive functional innovation.*



NATACHA POUTOUX & SACHA HOURCADE

natacha.sacha. est un duo de designers français talentueux aux compétences multiples. Leurs expériences en Matériaux de mobilier, d'architecture et l'attention qu'ils prêtent à la durabilité offrent une complémentarité singulière à tous les objets de la collection Horizon. *natacha.sacha. is a duo of talented French designers with a large set of skills. Their experiences in furniture, architecture and attention to sustainability is providing uncompromised complementary to all objects of the distinctive Horizon collection.*



GUILLAUME DELVIGNE

Guillaume débute auprès de prestigieux designers comme George Sowden et Marc Newson. Il se lance en solo en collaborant aussi bien avec des industriels que des artisans. De sa rencontre avec Lexon naît la collection Nomaday, alliant pureté des lignes et innovation. *Guillaume started with prestigious designers like George Sowden and Marc Newson. He went solo, collaborating with both industrialists and craftsmen. From his meeting with Lexon comes the Nomaday collection, combining purity of lines and innovation.*



NELSON FOSSEY

Nelson Fossey imagine des concepts où la technique se met au service de l'utilisateur. La collaboration avec Lexon permet de proposer des produits empreints d'une apparente simplicité, au caractère ludique et d'une facilité d'usage remarquable. *Nelson Fossey imagines concepts where technology is at the core of user experience. His collaboration with Lexon makes it possible to offer products with an apparent simplicity, a playful character and remarkable ease of use.*



MANUELA SIMONELLI & ANDREA QUAGLIO

Ils conçoivent, en collaboration avec Lexon, des objets offrant à la fois un design raffiné et une simplicité d'usage. La diversité des produits imaginés, le choix inattendus des formes poétiques, la sélection méticuleuse des matériaux, permettent de créer une réelle transversalité à travers l'ensemble de nos catégories, une singularité propre à l'ADN de notre marque. *Together with Lexon, they craft objects offering both a refined design and simplicity of use. The diversity of products, the unexpected choice of poetic forms, and the meticulous selection of materials allow us to create real transversality across all our categories, a singularity specific to our brand DNA.*



ADRIAN & JEREMY WRIGHT

Les deux frères ont suivi une formation d'ingénieur et ont de solides bases dans la compréhension de processus de fabrication. Leur approche est axée sur leur volonté de simplifier l'apparence et le fonctionnement des choses. *The brothers have a background in engineering and a solid understanding of the manufacturing process. Their approach is driven by a desire to reconsider and simplify how objects look and function.*



YOANN JACQUON

Il s'intéresse particulièrement aux aspects culturels et techniques de la cohabitation entre l'homme et la nature, et comment le design peut jouer le rôle de médiateur entre ces deux entités. Le design représente l'expression de l'intelligence humaine dans son rapport à la nature. *He is specifically interested in the cultural and technical aspects of coexistence between man and nature, and how design can play the role of mediator between these two entities. Design represents the expression of human intelligence in its relationship to nature.*



LUCA ARTIOLI

Une collaboration démarrée il y a plus de 20 ans avec un parcours sans faute dans la maîtrise de la bagagerie Lexon. *An harmonious collaboration started more than 20 years ago to master Lexon luggage collection.*



VALENTINA & SIMONE SPALVIERI

Le studio Spalvieri/Del Ciotto est un lieu où idées, recherche et expérimentation se rencontrent. Leur travail se caractérise par une simplicité à la fois formelle et fonctionnelle, alliée à une forte sensibilité. *The studio Spalvieri/Del Ciotto is a place where ideas, research and experimentation meet. Their work is characterized by a simplicity that is both formal and functional, combined with strong sensitivity.*



MARC BERTHIER

Une personnalité fondée sur le presque rien et l'intimité connue. Cet archétype et sa traduction contemporaine, entre discrétion et identité forte, est marqué par la justesse des décisions qui l'habitent. Matériaux, couleurs, forme : une image du design et du plaisir. *A personality based on the almost nothing and the deeply intimate. This archetype and its actual translation, right there between disappearance and showing off, still proposes an ideal picture of that design that aims at providing long-lasting pleasure.*

Sans oublier d'autres designers avec lesquels Lexon a eu le plaisir de collaborer ces 30 dernières années tels que : Philippe Starck, Pauline Deltour, Shoji Ito, Ionna Vautrin, Mathieu Lehanneur, Eugeni Quitllet, Elise Berthier & Anne Klepper, José Lévy, Marc Venot, Theo Williams et Claudio Gatto. *As well as other designers with whom Lexon had the pleasure to collaborate with, including: Philippe Starck, Pauline Deltour, Shoji Ito, Ionna Vautrin, Mathieu Lehanneur, Eugeni Quitllet, Elise Berthier & Anne Klepper, José Lévy, Marc Venot, Theo Williams and Claudio Gatto.*

TODAY

A global retail expansion strengthened with the opening of new branded locations.

Renforcement de notre présence à l'international notamment grâce à l'ouverture de nouveaux espaces de vente.



9000

Point of sales
Points de vente



90

Countries
Pays



LEXON, ALL DAY LONG

LEXON, TOUT AU LONG DE LA JOURNÉE

At LEXON, we create design objects that are meant to be part of your daily life, from morning till night. For that reason, we have rethought the way we define product categories and taken a transversal approach to better reflect how our objects fit your lifestyle.

Chez LEXON, nous créons des objets design qui vous accompagnent au quotidien, du matin jusqu'au soir. Pour cette raison, nous avons repensé la façon dont nous définissons nos catégories produits et adopté une approche transversale pour mieux refléter la façon dont nos objets s'adaptent à votre style de vie.

WAKE-UP
SE RÉVEILLER



LISTEN
ÉCOUTER



ILLUMINATE
ÉCLAIRER



CARE
PRENDRE SOIN DE SOI



CHARGE
CHARGER



WORK
TRAVAILLER



MOVE
SE DÉPLACER



CARRY
TRANSPORTER



WAKE-UP
SE RÉVEILLER



WAKE-UP *SE RÉVEILLER*

**FLIP
PREMIUM**



FLIP+



**FLIP+
TRAVEL**



MINUT



NEW
**MINA
SUNRISE**



NEW
**RAY
CLOCK**



NEW
**CONIC
CLOCK**



FLIP PREMIUM

Reversible LCD alarm clock in aluminum / Réveil LCD réversible en aluminium

FLIP PREMIUM

Design by Adrian & Jeremy Wright



AWARDS



- RÉVEIL RÉVERSIBLE**
REVERSIBLE ALARM CLOCK
- ÉCRAN VA LCD PURE BLACK**
PURE BLACK VA LCD DISPLAY
- CAPTEUR SONORE POUR ACTIVATION DE L'ÉCRAN**
SOUND SENSOR TO WAKE-UP SCREEN
- RÉPÉTITION DE L'ALARME & ÉCLAIRAGE**
SNOOZE & LIGHT UP
- SYSTÈME DE VERROUILLAGE POUR LE VOYAGE**
TRAVEL LOCK SYSTEM
- JUSQU'À 3 MOIS D'AUTONOMIE**
UP TO 3 MONTHS BATTERY LIFE
- RECHARGEABLE PAR USB-C**
RECHARGEABLE VIA USB-C
- FINITION ALUMINIUM**
ALUMINIUM FINISHING



Réveil LCD réversible - Faces ON/OFF - Ecran VA LCD pure black - Capteur sonore pour activation de l'écran - Commandes tactiles pour répéter l'alarme et ajuster la luminosité - Système de verrouillage pour le voyage - Autonomie : jusqu'à 3 mois - Rechargeable sur port USB-C (câble inclus) - Matériaux : Aluminium - PC.

Reversible LCD alarm clock - ON/OFF faces - Pure VA LCD display - Sound sensor to wake-up screen - Touch control for snooze and dimmer - Travel lock system - Battery life: Up to 3 months Rechargeable on USB-C port (cable included). Material: Aluminum - PC.

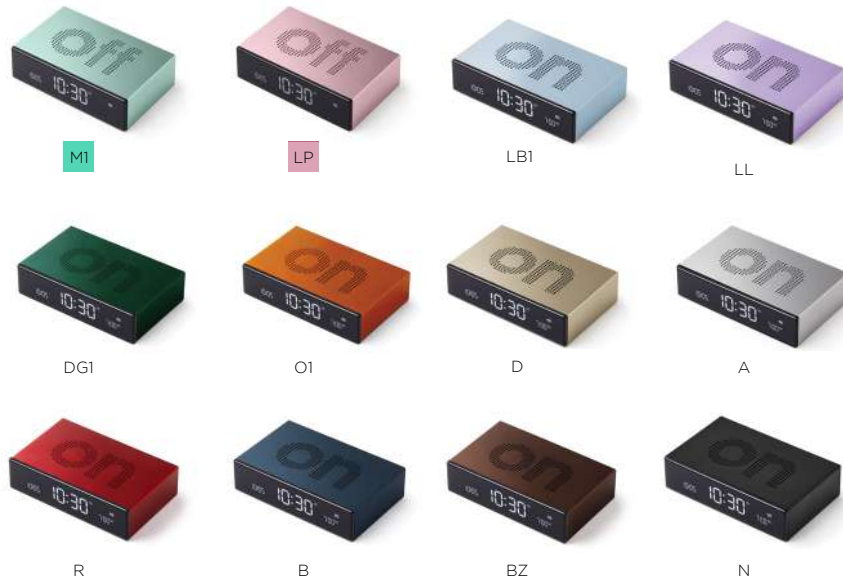

New colors 2023 / Nouvelles couleurs 2023

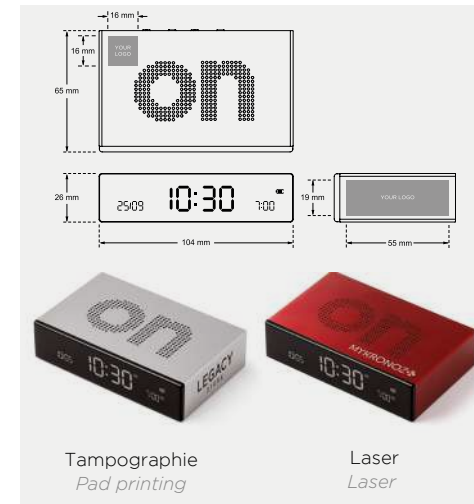

10,4 x 6,5 x 2,6 cm | P.Brut: 228 g
4.09 x 2.56 x 1.02" | G.W: 0.5 lbs



Colisage : 40p/11 kg | s/c: 20p
Carton : 40p/24.25 lbs | i/c:20p

FLIP+

Reversible alarm clock / Réveil réversible

FLIP+

Design by Adrian & Jeremy Wright



AWARDS



reddot design award
best of the best 2013



China
Good Design



DESIGN PLUS



RÉVEIL
RÉVERSIBLE



REVERSIBLE
ALARM CLOCK

RADIO-CONTRÔLÉ
(EUROPE UNIQUEMENT)



RADIO CONTROLLED
(EUROPE ONLY)

ÉCRAN LCD
ÉLECTROLUMINESCENT



ELECTROLUMINESCENT
LCD DISPLAY

SNOOZE/RÉTRO-ÉCLAIRAGE
TACTILE



TOUCH SENSOR
SNOOZE/LIGHT

2 PILES AAA
INCLUSES



2 AAA BATTERIES
INCLUDED

Réveil réversible radio-contrôlé (EU) - Faces ON/OFF - Ecran LCD électroluminescent - Contrôle tactile pour fonction snooze et éclairage de l'écran - Alimentation : 2 piles AAA (incluses) - Matériaux : ABS - Gomme.

Radio-controlled reversible alarm clock (EU) - ON/OFF faces - LCD electroluminescent display - Touch control to snooze and light display - Power supply: 2 AAA batteries (included) - Material: Rubber - ABS.

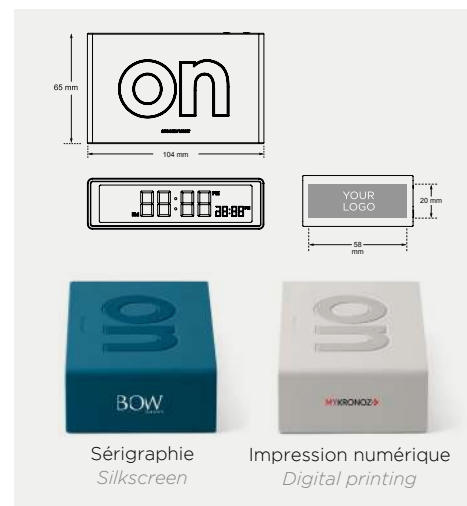

10,4 x 6,5 x 3 cm | P. Brut : 145 g
4 x 2,5 x 1,1" | G.W : 0.32 lbs



Colisage : 40 p/6,5 kg
Carton : 40p/14,33 lbs

FLIP+ TRAVEL

Mini reversible alarm clock / Mini réveil réversible

FLIP+ TRAVEL

Design by Adrian & Jeremy Wright



AWARDS



reddot design award
best of the best 2013



China
Good Design



GIFT OF THE YEAR
2018

DESIGN PLUS



RÉVEIL RÉVERSIBLE



REVERSIBLE
ALARM CLOCK

ADAPTÉ POUR LE VOYAGE



SUITABLE
FOR TRAVEL

ÉCRAN LCD ÉLECTROLUMINESCENT



ELECTROLUMINESCENT
LCD DISPLAY

SNOOZE/RÉTRO-ÉCLAIRAGE TACTILE



TOUCH SENSOR
SNOOZE/LIGHT

2 PILES AAA INCLUSES



2 AAA BATTERIES
INCLUDED

Mini réveil réversible de voyage - Faces ON/OFF - Ecran LCD électroluminescent - Contrôle tactile pour fonction snooze et éclairage de l'écran - Alimentation : 2 piles AAA (incluses) - Matériaux : ABS - Gomme.

Mini reversible travel alarm clock - ON/OFF faces - LCD electroluminescent display - Touch control to snooze and light display - Power supply: 2 AAA batteries (included) - Material: Rubber - ABS.

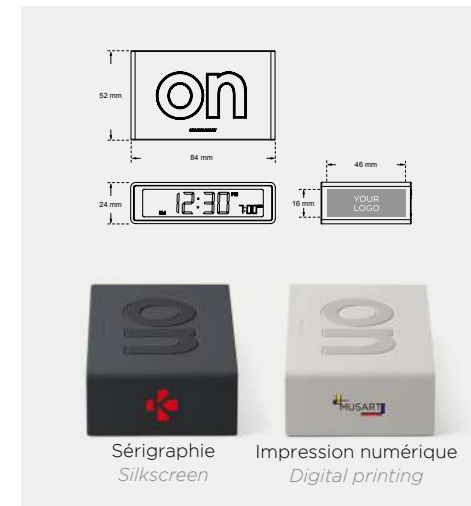

8,4 x 5,2 x 2,4 cm | P. Brut : 115 g
3.3 x 2 x 0.9" | G.W. : 0.26 lbs



Colisage : 40 pcs / 5.1 kg
Carton : 40p/11.24 lbs

MINUT

Mini alarm clock / Mini réveil

MINUT

Design by Manuela Simonelli & Andrea Quaglio



AWARD



reddot winner 2023



- FORMAT DE POCHE**
POCKET-SIZED
- ÉCRAN VA LCD PURE BLACK**
PURE BLACK VA LCD DISPLAY
- RÉPÉTITION DE L'ALARME & ÉCLAIRAGE**
SNOOZE & LIGHT UP
- JUSQU'À 6 MOIS D'AUTONOMIE**
UP TO 6 MONTHS BATTERY LIFE
- RECHARGEABLE PAR USB-C**
RECHARGEABLE VIA USB-C
- FINITION ALUMINIUM**
ALUMINIUM FINISHING

Réveil compact avec écran LCD noir et batterie rechargeable intégrée - Commandes tactiles - Fonction snooze - Autonomie: Jusqu'à 6 mois - Temps de charge: 3h - Rechargeable sur port USB Type-C. Matériaux : Aluminium - ABS.

Compact size alarm clock with full black LCD display - Rechargeable battery built-in - Touch controls - Snooze function - Battery life: Up to 6 months - Charging time: 3h - Rechargeable on USB Type-C port. Material: Aluminum / ABS.

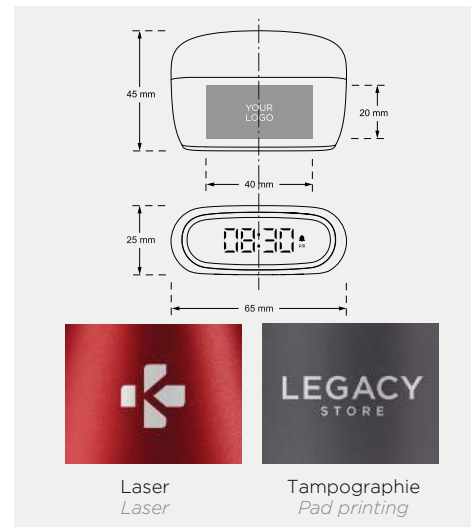
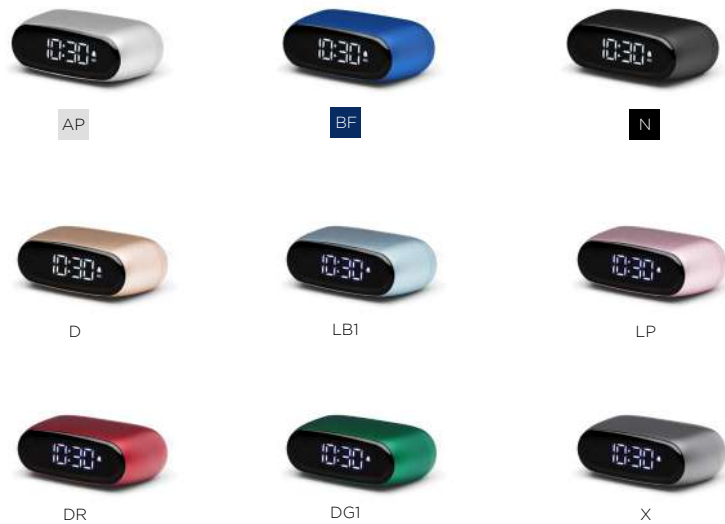

6.5 x 4.5 x 2.5 cm / P. Brut : 95 g
2.36 x 1.57 x 0.79" / G.W: 0.21 lbs

Colisage: 40p / Env. 4.1 kg
Carton: 40p / Approx. 9.04 lbs

MINA SUNRISE

Sunrise alarm clock / Lampe réveil simulateur d'aube

MINA SUNRISE

Design by Manuela Simonelli & Andrea Quaglio



SIMULATION DE L'AUBE ET DU CRÉPUSCULE



SUNRISE & SUNSET SIMULATION

MÉLODIES ET SONS NATURELS



MELODIES & NATURAL SOUNDS

RÉPÉTITION DE L'ALARME



SNOOZE & DIMMER

LAMPE LED AVEC 9 COULEURS D'ÉCLAIRAGE



LED LAMP WITH 9 COLORS

PORT DE CHARGE USB-C



USB-C CHARGING PORT

FINITION EN ALUMINIUM



ALUMINIUM FINISHING

Lampe réveil simulateur d'aube - Écran LCD VA pur - Simulation du lever et du coucher du soleil - Mélodies & sons naturels - Lampe avec 9 couleurs de LED - Puissance lumineuse maximale : 70 lm - Variateur d'intensité - Commandes tactiles - Rechargeable - Jusqu'à 4 mois d'autonomie - Temps de charge : 5h - Alimentation : sur port USB-C (câble inclus) - Matériaux : Aluminium - ABS.

Sunrise alarm clock - Pure VA LCD display - Sunrise & Sunset simulation - Melodies & natural sounds - Lamp with 9 LED colors - Maximum light output: 70 lm - Dimmer - Touch controls - Rechargeable - Up to 4 months of battery life - Charging time: 5h - Power supply: via USB-C (cable included) - Materials: Aluminum - ABS.



New colors 2023 / Nouvelles couleurs 2023

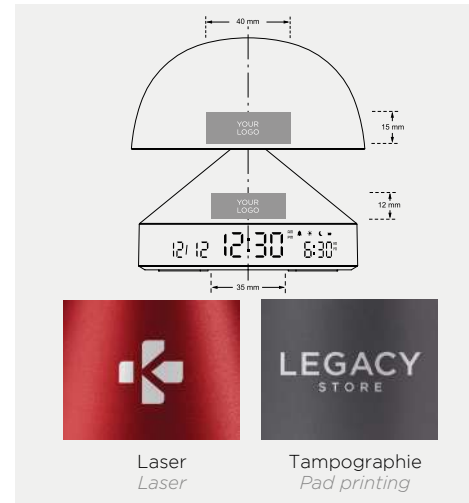

11 x 11 x 9.3 cm / P. Brut : 430 g
Ø4.33 x 4.33" / G.W: 0.95 lbs



Colisage: 20p / 9.6 kg
Carton: 20p / Approx. 21.17 lbs

RAY CLOCK

LCD alarm clock with temperature / humidity display
Réveil LCD avec affichage température / humidité



RAY CLOCK

Design by neil poulton



- ÉCRAN VA LCD
PURE BLACK



PURE BLACK
VA LCD DISPLAY
- MÉLODIES ET SONS
NATURELS



MELODIES &
NATURAL SOUNDS
- RÉPÉTITION DE
L'ALARME
& ÉCLAIRAGE



SNOOZE
& LIGHT UP
- SUIVI DE LA TEMPÉRATURE
INTÉRIEURE ET DE
L'HUMIDITÉ



INDOOR TEMPERATURE &
HUMIDITY MONITORING
- RECHARGEABLE
PAR USB-C



RECHARGEABLE
VIA USB-C
- FINITION
ALUMINIUM



ALUMINIUM
FINISHING

Réveil LCD avec affichage température / humidité - Capteur de mouvement infrarouge pour la fonction snooze - Inclinaison pour activer/désactiver l'alarme - Mélodies & sons naturels - Affichage de la température intérieure et de l'humidité relative - Autonomie : Jusqu'à 6 mois - Rechargeable sur port USB-C (câble inclus) - Temps de charge : 4h - Matériaux : Aluminium - ABS.

LCD alarm clock with temperature / humidity display - Infrared motion sensor for snooze function - Tilt to activate/deactivate alarm - Melodies & natural sounds - Indoor temperature and relative humidity display - Battery life: Up to 6 months - Rechargeable via USB-C port (cable included) - Charging time: 4h - Material: Aluminum - ABS.



9 x 4.4 x 7.4 cm / P. Brut: 300 g
3.54 x 1.73 x 2.91" / G.W: 0.66 lbs

Colisage: 40 pcs / Env. 12kg
Carton: 40 pcs / Approx. 26.45 lbs

CONIC CLOCK

Radio alarm clock with FM & built-in Bluetooth® speaker
Radio réveil avec FM & enceinte Bluetooth® intégrée

CONIC CLOCK

Design by Lidia Gomez



- 
RADIO FM
FM RADIO
- 
ENCEINTE BLUETOOTH®
BLUETOOTH® SPEAKER
- 
ÉCRAN VA LCD PURE BLACK
PURE BLACK VA LCD DISPLAY
- 
MÉLODIES ET SONS NATURELS
MELODIES & NATURAL SOUNDS
- 
RÉPÉTITION DE L'ALARME & ÉCLAIRAGE
SNOOZE & LIGHT UP
- 
SUIVI DE LA TEMPÉRATURE INTÉRIEURE ET DE L'HUMIDITÉ
INDOOR TEMPERATURE & HUMIDITY MONITORING
- 
PORT DE CHARGE USB-C
USB-C CHARGING PORT
- 
FINITION ALUMINIUM
ALUMINIUM FINISHING

Radio réveil avec FM & enceinte Bluetooth® intégrée - Double alarme avec radio FM ou mélodies & sons naturels - Grand écran LCD - Luminosité ajustable - Affichage de la température intérieure et de l'humidité relative - Commandes tactiles pour un accès facile aux modes Bluetooth/radio FM et aux réglages des paramètres - Rechargeable - Alimenté sur port USB-C (câble inclus) - Matériaux: Aluminium-ABS. Marquage conseillé : laser - tampographie.

Radio alarm clock with FM & built-in Bluetooth® speaker- Dual alarm with FM radio or melodies & natural sounds - Large LCD display - Adjustable brightness - Indoor temperature and relative humidity display - Touch controls for easy access to Bluetooth/FM radio modes and device settings - Rechargeable - Powered by USB-C port (cable included) - Material: Aluminum - ABS. Suggested branding: laser - pad print.



GH3



CR3



PB3



L3



GA3



PG3

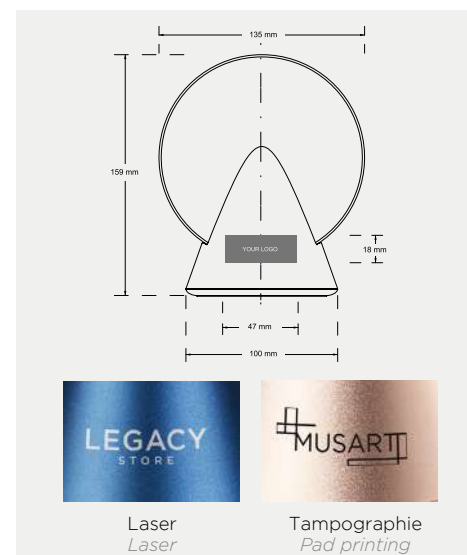

Ø13.5 x 15.9 cm / P. Brut: 540 g
 Ø5.31 x 6.26" / G.W: 1.19 lbs

Colisage: 12 pcs / Env. 7 kg
 Carton: 12 pcs / Approx. 15.43 lbs

LISTEN
ÉCOUTER



LISTEN ÉCOUTER

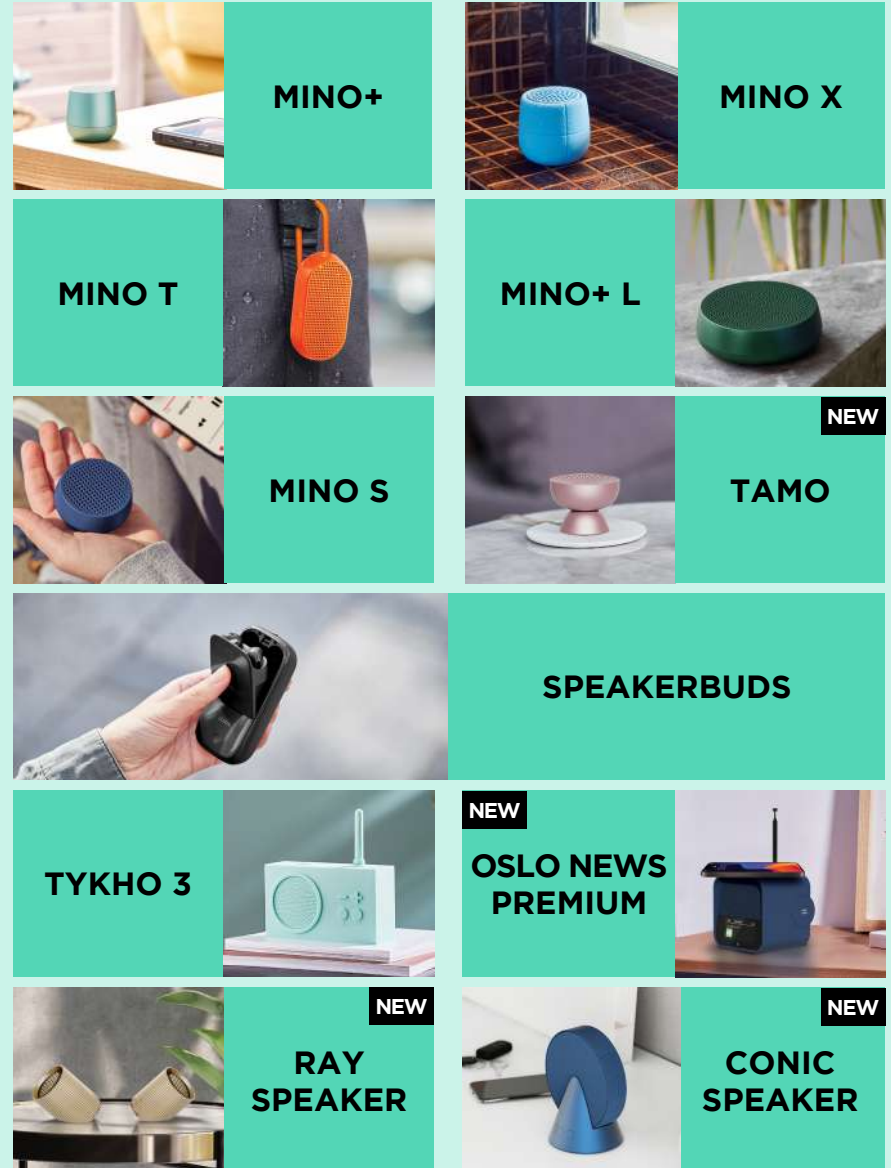

MINO+

Mini Bluetooth® speaker / Mini enceinte Bluetooth®

MINO+

Design by Manuela Simonelli & Andrea Quaglio



- ENCEINTE BLUETOOTH®**



BLUETOOTH® SPEAKER
- APPARABLE PAR TWS**



PAIRABLE VIA TWS
- MICRO MAINS-LIBRES**



HANDS-FREE MIC
- DÉCLENCHEUR SELFIE**



SELFIE REMOTE
- PORT USB-C**



USB-C PORT
- RECHARGEABLE PAR INDUCTION**



WIRELESSLY RECHARGEABLE
- FINITION EN ALUMINIUM**



ALUMINUM FINISHING



Enceinte Bluetooth® rechargeable par induction - Appairable - Micro mains-libres - Déclencheur selfie - Autonomie : 3h - Temps de charge : 1h - Rechargeable sur port USB-C (câble inclus) ou par induction
Matériaux : Aluminium - ABS.

Wirelessly rechargeable Bluetooth® speaker - Pairable - Hands-free mic - Selfie control - Battery life: 3h - Charging time: 1h - Rechargeable on USB-C port (cable included) or wirelessly. Material: Aluminum - ABS.



Colors on request / Couleurs sur demande



3,7 x 3,7 cm | P. Brut : 73 g
5.5 x 1.7 x 3.1" | G.W. : 0.85 lbs



Colisage : 40 p/3,740 kg | s/c : 10 p
Carton : 20p/ 24.14 lbs / i/c: 10p

MINO X

Floating Bluetooth® speaker / Enceinte Bluetooth® flottante

MINO X

Design by Manuela Simonelli & Andrea Quaglio



Enceinte Bluetooth® flottante - Résistance à l'eau IPX7 - Appairable - Rechargeable - Micro mains-libres - Déclencheur selfie - Autonomie : 3h - Temps de charge : 1h - Rechargeable sur port USB-C (câble inclus) - Matériaux : ABS - gomme rebondissante - finition silicone.

Floating Bluetooth® speaker - Water resistance IPX7 - Pairable - Rechargeable - Hands-free mic - Selfie control - Battery life: 3h - Charging time: 1h - Rechargeable on USB-C port (cable included) - Material: ABS - bouncy rubber - silicone finishing.

- ENCEINTE BLUETOOTH®**



BLUETOOTH® SPEAKER
- APPAIRABLE PAR TWS**



PAIRABLE VIA TWS
- MICRO MAINS-LIBRES**



HANDS-FREE MIC
- DÉCLENCHEUR SELFIE**



SELFIE REMOTE
- RECHARGEABLE PAR USB-C**



RECHARGEABLE VIA USB-C
- RÉSISTANCE À L'EAU IPX7**



IPX7 WATER RESISTANT

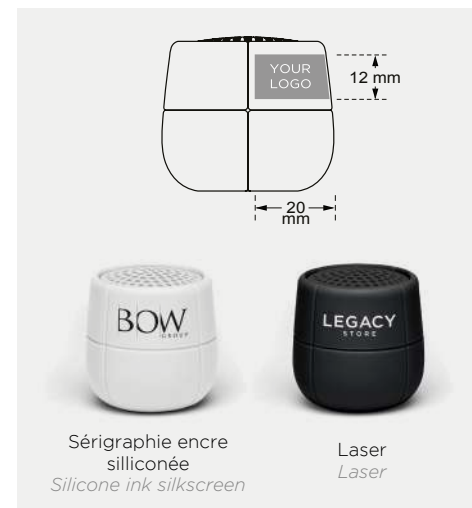

Ø 4,3 x 4 cm | P. Brut: 135 g
 Ø 1.6 x 1.5" | G.W: 0.29 lbs

Colisage : 40 p/ 6,19 kg | s/c : 20 p
 Carton : 40p/ 13.8 lbs / i/c: 20p

MINO T

Bluetooth® speaker with built-in carabiner / *Enceinte Bluetooth® avec mousqueton intégré*

MINO T

Design by Manuela Simonelli & Andrea Quaglio



AWARD
reddot winner 2021

- ENCEINTE BLUETOOTH®**



BLUETOOTH® SPEAKER
- APPAIRABLE PAR TWS**



PAIRABLE VIA TWS
- MOUSQUETON EN ACIER INOXYDABLE**



STAINLESS STEEL CARABINER
- MICRO MAINS-LIBRES**



HANDS-FREE MIC
- DÉCLENCHEUR SELFIE**



SELFIE REMOTE
- RECHARGEABLE PAR USB-C**



RECHARGEABLE VIA USB-C
- ADAPTÉE À UN USAGE EXTÉRIEUR (IPX4)**



SUITABLE FOR OUTDOOR USE (IPX4)

Enceinte Bluetooth® avec mousqueton intégré - Appairable par TWS - Micro mains-libres - Déclencheur selfie - Résistance à l'eau IPX4 - Autonomie : 5h - Temps de charge : 2h - Rechargeable sur port USB-C (câble inclus) - Matériaux : Socle en ABS - Mousqueton en ABS - Alliage de zinc.

Bluetooth® speaker with integrated carabiner - Pairable via TWS - Hands-free mic - Selfie control - Water resistance IPX4 - Playtime: 5h - Charging time: 2h - Rechargeable on USB-C port (cable included) - Material: ABS stand - ABS - Zinc alloy hook.

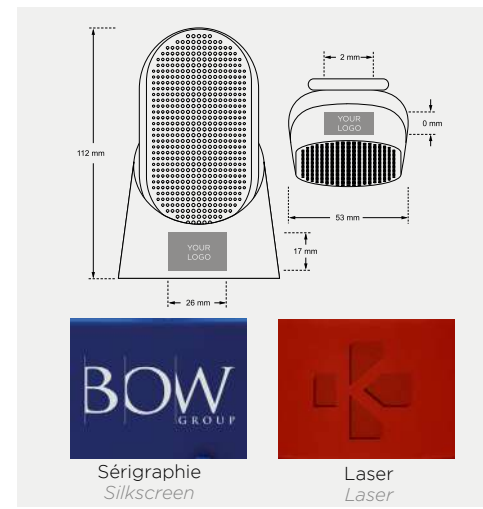

5,3 x 2,9 x 9,7cm | P. Brut : 310 g
2,08 x 1,14 x 3,81" | G.W : 0.7 lbs

Colisage: 20p /6,640 kg
Carton : 20p/15 lbs

MINO+ L

Portable Bluetooth® speaker / Enceinte Bluetooth® nomade

MINO+ L

Design by Manuela Simonelli & Andrea Quaglio



ENCEINTE BLUETOOTH®	APPAIRABLE PAR TWS	MICRO MAINS-LIBRES	DÉCLENCHEUR SELFIE	PORT DE CHARGE USB-C	RECHARGEABLE PAR INDUCTION	ADAPTÉE À UN USAGE EXTÉRIEUR (IPX4)	FINITION EN ALUMINIUM
BLUETOOTH® SPEAKER	PAIRABLE VIA TWS	HANDS-FREE MIC	SELFIE REMOTE	USB-C CHARGING PORT	WIRELESSLY RECHARGEABLE	SUITABLE FOR OUTDOOR USE (IPX4)	ALUMINUM FINISHING



Enceinte Bluetooth® adaptée pour l'extérieur - Fonction TWS pour une expérience stéréo - Batterie rechargeable - Résistance à l'eau classée IPX4 pour un usage en extérieur (conception étanche aux éclaboussures et au sable) - Micro mains-libres intégré pour les conférences téléphoniques - Autonomie: 5h - Temps de charge: 2h - Rechargeable sur port USB Type-C (câble inclus) ou par induction. Matériaux : Aluminium - ABS.

Outdoor friendly Bluetooth speaker - TWS compatible for stereo effect - Rechargeable battery and IPX4 rating for outdoor usage (spillproof and sand proof design) - Hands-free and built-in microphone for conference calls - Battery life: 5h - Charging time: 2h - Rechargeable on USB Type-C port (cable included) or wirelessly. Material: Aluminum - ABS.

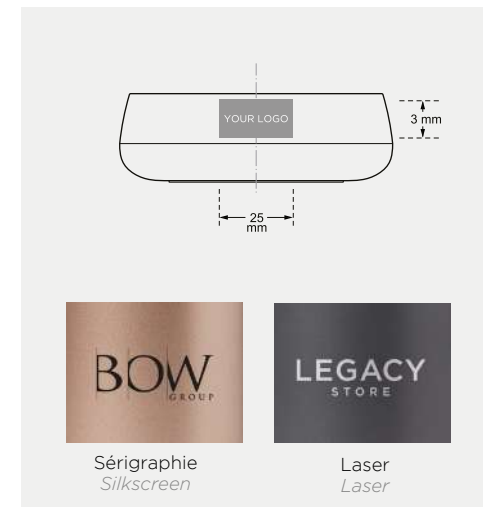

Ø9,3 x 3 cm / P.Brut: 358 g
 Ø3.66 x 1.18" / G.W: 0.8 lbs

Colisage: 20p / 7 kg
 Carton : 20p/15.43 lbs

MINO S

Pocket-sized Bluetooth® speaker / Enceinte bluetooth® de poche

MINO S

Design by Manuela Simonelli & Andrea Quaglio



ENCEINTE
BLUETOOTH®



BLUETOOTH®
SPEAKER

APPAIRABLE
PAR TWS



PAIRABLE
VIA TWS

MICRO
MAINS-LIBRES



HANDS-FREE
MIC

DÉCLENCHEUR
SELFIE



SELFIE
REMOTE

RECHARGEABLE
PAR USB-C



RECHARGEABLE
VIA USB-C

Enceinte Bluetooth® de poche - Appairable par TWS - Rechargeable - Micro mains-libres - Déclencheur selfie - Autonomie : 3h - Temps de charge : 1h - Rechargeable sur port USB-C (câble inclus) - Matériaux : ABS.

Pocket-sized Bluetooth® speaker - Pairable via TWS - Rechargeable - Hands-free mic - Selfie control - Playtime: 3h - Charging time: 1h - Rechargeable on USB-C port (cable included) - Material: ABS.



N9



DB9



K9



PO



R9



MW

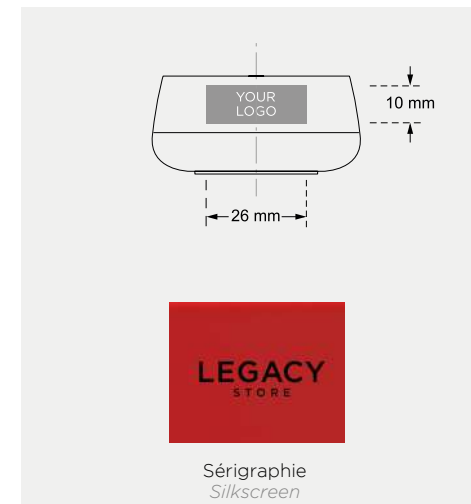

Sérigraphie
Silkscreen



Ø5,4 x 2,5 cm | P.Brut: 85 g
Ø2.1 x 0.98" | G.W : 0.19 lbs

Colisage: 40p/ 4kg | s/c:20p
Carton : 40p/ 8.75 lbs / i/c: 20p

TAMO

Infinitely pairable mini Bluetooth® speaker
Mini enceinte Bluetooth® connectable à l'infini



- ENCEINTE
BLUETOOTH®



BLUETOOTH®
SPEAKER
- CONNECTABLE
À L'INFINI



INFINITELY
PAIRABLE
- CONTRÔLE TACTILE
POUR LES COMMANDES
AUDIO



TOUCH CONTROL
FOR AUDIO
CONTROLS
- MICRO
MAINS-LIBRES



HANDS-FREE
MIC
- DÉCLENCHEUR
SELFIE



SELFIE
REMOTE
- RECHARGEABLE
PAR USB-C



RECHARGEABLE
VIA USB-C
- RECHARGEABLE
PAR INDUCTION



WIRELESSLY
RECHARGEABLE
- FINITION
EN ALUMINIUM



ALUMINIUM
FINISHING

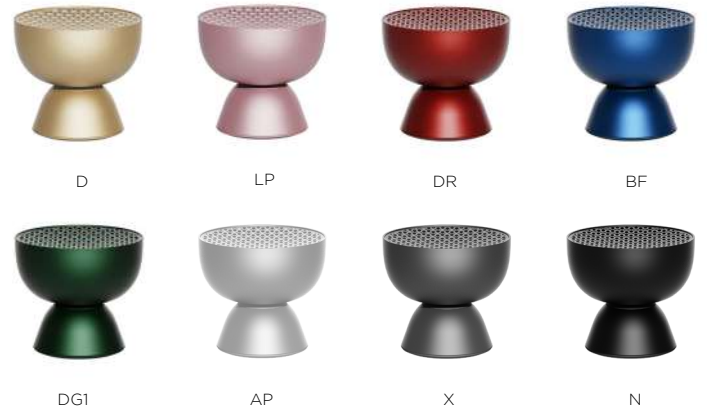

TAMO

Design by Manuela Simonelli & Andrea Quaglio



Mini enceinte Bluetooth® connectable à l'infini -
Commande tactile sur la base pour les commandes
audio et ajustement du volume - Micro mains
libres - Déclencheur selfie - Autonomie : Jusqu'à
3h - Rechargeable sur port USB-C (câble
inclus) ou par induction - Temps de charge : 1h.
Matériaux: Aluminium-ABS. Marquage conseillé :
tampographie.



*Infinitely pairable mini Bluetooth® speaker - Touch
control on base for audio controls and volume
adjustment - Hands-free microphone - Selfie control
- Battery life: Up to 3h - Rechargeable via USB-C
port (cable included) or wirelessly - Charging time:
1h - Material: Aluminum-ABS. Suggested branding:
pad print.*

Ø5.3x 42 cm / P. Brut: 90 g
Ø2.09 x 1.65" / G.W: 0.21 lbs

Colisage: 40 pcs / Env. 4.2 kg
Carton: 40 pcs / Approx. 9.25 lbs

SPEAKERBUDS

2-in-1 true wireless stereo earbuds + built-in Bluetooth® speaker
 Écouteurs sans fil TWS 2-en-1 avec enceinte Bluetooth® intégrée

SPEAKERBUDS

Design by Alain Berteau



AWARDS



reddot winner 2022



- ÉCOUTEURS SANS FIL TWS

TWS EARBUDS
- ENCEINTE PORTABLE

PORTABLE SPEAKER
- DOUBLE MICROPHONE

DUAL MICROPHONE
- RÉDUCTION DU BRUIT AMBIANT

ENVIRONMENT NOISE CANCELLING
- JUSQU'À 24 H D'AUTONOMIE

UP TO 24 HOURS PLAYTIME
- RECHARGEABLE PAR USB-C

RECHARGEABLE VIA USB-C
- FINITION CUIR SYNTHÉTIQUE

SYNTHETIC LEATHER FINISHING



Écouteurs sans fil TWS 2-en-1 avec enceinte Bluetooth® intégrée - Double Microphone - Appels mains libres - Commandes vocales - Jusqu'à 6h de lecture musicale sur les écouteurs et 18h supplémentaires avec son étui de recharge - Rechargeable via USB-C (câble inclus). Matériaux : ABS enveloppé de cuir synthétique.

2-in-1 True Wireless Stereo Earbuds with Bluetooth® speaker - Dual Microphone - Hands-free calls - Voice commands - Up to 6h music playtime on buds and an extra 18h with its charging case - Rechargeable via USB-C port (cable included). Material: ABS wrapped with synthetic leather.

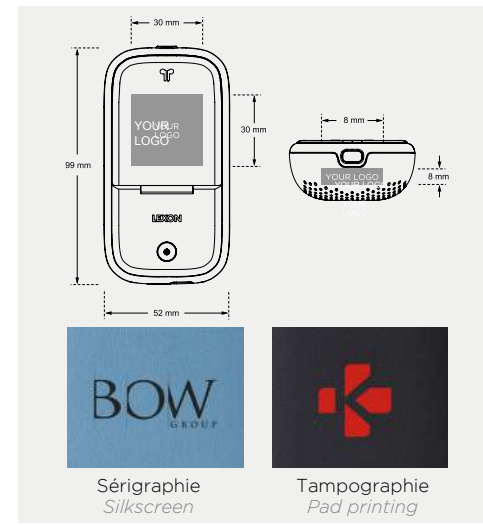

9.9 x 5.2 x 2.5 cm | P.Brut: 120g
 3.89 x 2.05 x 0.98" | G.W : 0.26 lbs

Colisage: 40p/7kg 1 s/c:20p
 Carton : 40p/ 15.42 lbs / i/c: 20p

TYKHO 3

FM radio & Bluetooth® speaker / Radio FM & enceinte Bluetooth®

TYKHO 3

Design by Marc Berthier



AWARD



RADIO FM
FM RADIO

ENCEINTE BLUETOOTH®
BLUETOOTH® SPEAKER

20 HEURES D'AUTONOMIE
20 HOURS PLAYTIME

RECHARGEABLE PAR MICRO-USB
RECHARGEABLE VIA MICRO-USB

RÉSISTE AUX ÉCLABOUSSURES
RÉSISTE AUX ÉCLABOUSSURES

Radio FM - Enceinte Bluetooth® - Résiste aux projections d'eau - Plage de fréquence : FM 88-108MHz - Portée Bluetooth® : 10m - Autonomie : 20h - Temps de charge : 4h - Rechargeable sur port Micro-USB (câble inclus) - Matériaux : Gomme silicone.

FM radio - Bluetooth® speaker - Splash-proof - Frequency range: FM 88-108MHz - Bluetooth® range: 10m - Battery life: 20h - Charging time: 4h - Rechargeable on Micro-USB port (cable included) - Material: Silicone rubber case.

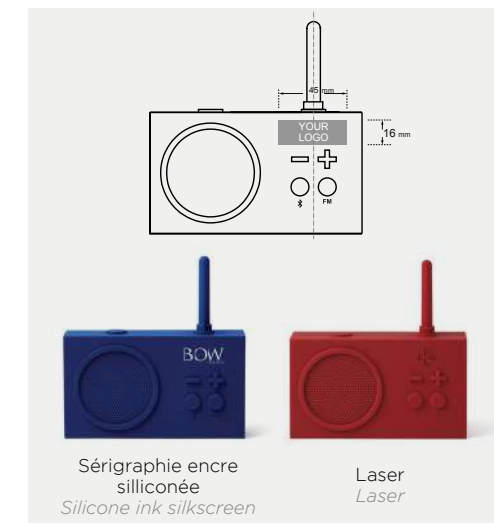

114 x 4,5 x 8,1 cm | P.Brut: 388g
5.5 x 1.7 x 3.1" | G.W : 0.85 lbs

Colisage: 20p/10.95kg | s/c:10p
Carton : 20p/ 24.14 lbs / i/c: 10p

OSLO NEWS PREMIUM

DAB & FM alarm clock radio / Bluetooth® speaker / Wireless charger
Radio-réveil DAB & FM / Enceinte Bluetooth® / Chargeur à induction



- RADIO RÉVEIL DAB + FM**
DAB+ FM
DAB + FM ALARM CLOCK RADIO
- ENCEINTE BLUETOOTH®**
BLUETOOTH® SPEAKER
- ÉCRAN COULEUR**
COLOR SCREEN
- STATION DE CHARGE SANS FIL 10W**
WIRELESS CHARGING STATION 10W
- CERTIFIÉ Qi**
Qi CERTIFIED
- ALIMENTATION VIA USB-C**
POWER SUPPLY VIA USB-C

OSLO NEWS PREMIUM

Design by Manuela Simonelli & Andrea Quaglio



Réveil radio DAB/FM avec solution de charge par induction - Enceinte Bluetooth - Écran couleur - fonctionne avec tous les appareils compatibles Qi - Alimenté par un connecteur USB-C (non inclus) - sur port USB Type-C (câble inclus) - Matériaux : Cuir synthétique - ABS.

DAB Radio Bedside alarm clock with Qi wireless charging - Bluetooth speaker and FM Radio compatible - Operated with front color screen - Compatible with any Qi devices - Powered with USB-C connector (not included) - on USB Type-C port (cable included) - Material: Synthetic leather - ABS.



N DB W DR

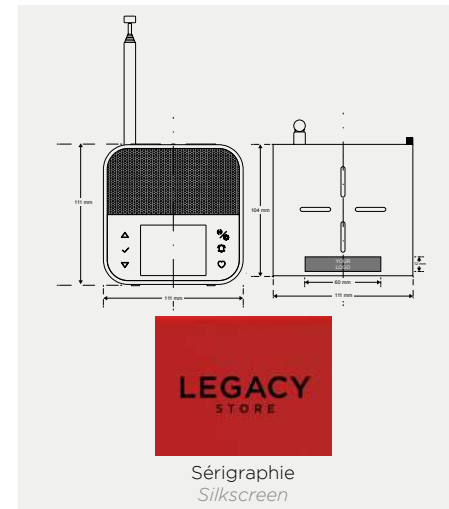

11 x 11 x 10.4 cm / P. Brut: 800 g
4.33 x 4.33 x 4.1" / G.W: 1.76 lbs



Colisage: 8p / Env. 8.5 kg
Carton: 8p / Approx. 19 lbs

RAY SPEAKER

Set of magnetic Bluetooth® speakers / Duo d'enceintes Bluetooth® magnétiques



SET D'ENCEINTES
BLUETOOTH®



BLUETOOTH®
SPEAKER SET

APPAIRABLE
PAR TWS



PAIRABLE
VIA TWS

FIXATION
MAGNÉTIQUE



MAGNETIC
ATTACHMENT

RECHARGEABLE
PAR USB-C



RECHARGEABLE
VIA USB-C

ADAPTÉE À UN USAGE
EXTÉRIEUR (IPX4)



SUITABLE FOR
OUTDOOR USE (IPX4)

FINITION
ALUMINIUM



ALUMINIUM
FINISHING



VG3



OB3



SR3



MN3



RA3

RAY SPEAKER

Design by neil poulton



Duo d'enceintes Bluetooth® magnétiques - Compatible TWS pour une expérience stéréo - Résistante à l'eau (IPX4) - Autonomie : Jusqu'à 6h - Rechargeable sur port USB-C (câble inclus) - Temps de charge : 2h - Matériaux: Aluminium - Métal magnétique - ABS - Silicone.

Set of magnetic Bluetooth® speakers - TWS compatible for a stereo experience - Water resistant (IPX4) - Battery life: up to 6h - Rechargeable via USB-C port (cable included) - Charge time: 2h - Material: Aluminum - Magnetic metal - ABS - Silicon.

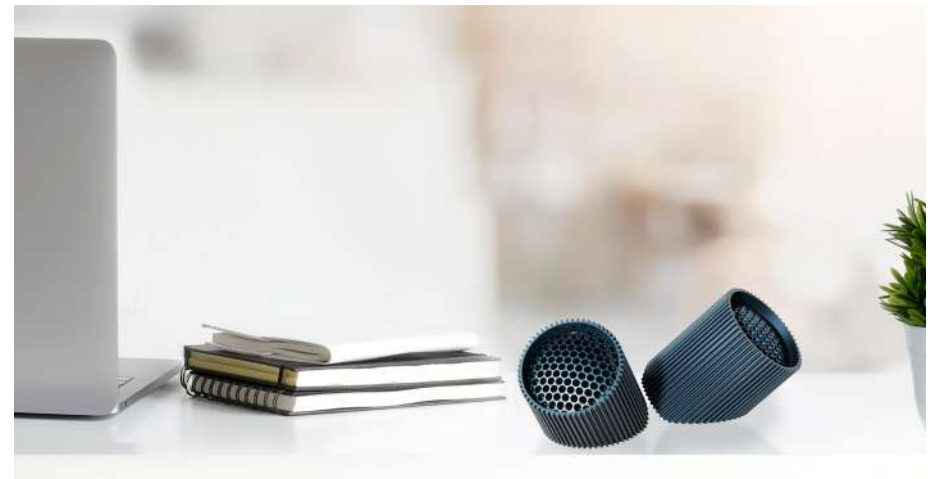

Ø4.7 x 5.7 cm / P. Brut: 250 g
Ø1.85 x 2.24" / G.W: 0.55 lbs

Colisage: 40 pcs / Env. 11 kg
Carton: 40 pcs / Approx. 24.25 lbs

CONIC SPEAKER

360° Bluetooth® speaker / Enceinte Bluetooth® 360°

CONIC SPEAKER

Design by Lidia Gomez



<p>ENCEINTE BLUETOOTH®</p> <p>BLUETOOTH® SPEAKER</p>	<p>SON 360°</p> <p>360° SOUND</p>	<p>APPAIRABLE PAR TWS</p> <p>PAIRABLE VIA TWS</p>	<p>BOUTONS POUR LES COMMANDES AUDIO</p> <p>BUTTONS FOR AUDIO CONTROLS</p>	<p>RECHARGEABLE PAR USB-C</p> <p>RECHARGEABLE VIA USB-C</p>	<p>ADAPTÉE À UN USAGE EXTÉRIEUR (IPX4)</p> <p>SUITABLE FOR OUTDOOR USE (IPX4)</p>	<p>BASE EN ALUMINIUM</p> <p>ALUMINUM BASE</p>
---	--	--	--	--	--	--

Enceinte Bluetooth 360° - Boutons pour les commandes audio et ajustement du volume - Compatible TWS pour une expérience stéréo - Autonomie : Jusqu'à 12h - Rechargeable sur port USB-C (câble inclus) - Temps de charge : 4h - Matériaux: Aluminium - Tissu - ABS.

360° Bluetooth speaker - Buttons for audio controls and volume adjustment - TWS compatible for a stereo experience - Battery life: Up to 12h - Rechargeable via USB-C port (cable included) - Charging time: 4h - Material: Aluminum - Fabric - ABS.



GH3



CR3



PB3



L3



GA3



PG3

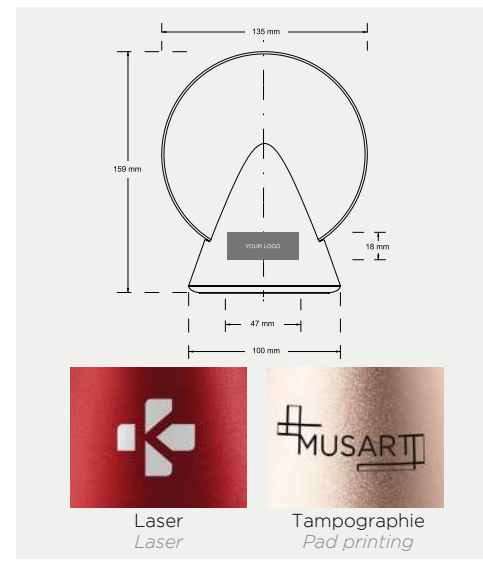

Ø13,5 x 15,9 cm / P. Brut: 540 g
Ø5.31 x 6.26" / G.W: 1.19 lbs



Colisage: 12 pcs / Env.7 kg
Carton: 12 pcs / Approx. 15.43 lbs

ILLUMINATE
ÉCLAIRER



ILLUMINATE ÉCLAIRER



MINA
COLLECTION

NEW

LUMA
COLLECTION



HORIZON
HANGING
LAMP



BOLLA+

ORBE



NEW

BUBBLE
LAMP



NEW

LANTERN



NEW

TERRACE+



NEW

STELI



NEW

CONIC LAMP



NEW

MIMI



NEW

HELIA

MINA

Mini LED lamp (3 inches) / Mini lampe LED (8 cm)

MINA

Design by Manuela Simonelli & Andrea Quaglio



LUMIÈRE BLANCHE
CHAUDE OU FROIDE



WARM OR COLD
WHITE LIGHT

VARIATEUR
D'INTENSITÉ



DIMMER

JUSQU'À 12 HEURES
D'AUTONOMIE



UP TO 12 HOURS
BATTERY LIFE

RECHARGEABLE
PAR USB-C



RECHARGEABLE
VIA USB-C

FINITION
ALUMINIUM



ALUMINUM
FINISHING

Mini Lampe LED - Lumière blanche froide ou chaude - Puissance lumineuse maximale : 20 lm - Variateur d'intensité à mémoire - Autonomie : jusqu'à 12h (testée à 75% de luminosité, 22°C de température ambiante) - Temps de charge : 2h - Rechargeable sur port USB-C (câble inclus). Matériaux : Aluminium - ABS.

Mini LED lamp - Cool or warm white light - Maximum light output: 20 lm - Memory dimmer - Battery life: up to 12h (tested at 75% brightness, 22°C ambient indoor temperature) - Charging time: 2h - Rechargeable on USB-C port (cable included). Material: Aluminum - ABS.



Ø 7 x 8,3 cm | P.Brut : 165g
Ø2.76 x 3.27" | GW : 0,36 lbs



Colisage: 40p/8,2 kg | s/c : 20p
Carton : 40p/ 18 lbs | i/c: 20p

MINA M

Medium portable LED lamp (4 inches) / *Lampe LED portable medium (11 cm)*

MINA M

Design by Manuela Simonelli & Andrea Quaglio



- LAMPE AVEC 9 COULEURS DE LED**
LAMP WITH 9 LED COLORS
- VARIATEUR D'INTENSITÉ**
DIMMER
- JUSQU'À 24 HEURES D'AUTONOMIE**
UP TO 24 HOURS BATTERY LIFE
- PORT DE CHARGE USB-C**
USB-C CHARGING PORT
- RECHARGEABLE PAR INDUCTION**
WIRELESSLY RECHARGEABLE
- ADAPTÉE À UN USAGE EXTÉRIEUR (IPX4)**
SUITABLE FOR OUTDOOR USE (IPX4)
- FINITION ALUMINIUM**
ALUMINIUM FINISHING

Lampe LED portable medium - Lumière blanche froide ou chaude +7 couleurs - Puissance lumineuse maximale : 40 lm - Contrôle de la lumière par pression - Variateur d'intensité - Résistance à l'eau IPX4 - Autonomie : jusqu'à 24h (testée à 75% de luminosité, 22°C de température ambiante) - Temps de charge : 2h - Rechargeable sur port USB-C (câble inclus) ou par induction - Matériaux : Aluminium - ABS.

Medium portable LED lamp - Cool or warm white light +7 colors - Maximum light output: 40 lm - Push activation light - Dimmer - Water resistant IPX4 - Battery life: up to 24h (tested at 75% brightness, 22°C ambient indoor temperature) - Charging time: 2h - Rechargeable on USB-C port (cable included) or wirelessly - Material: Aluminum - ABS.



Ø9,2 x 11 cm | P. Brut : 350 g
Ø3.62 x 4.33" | G.W. : 0.77 lbs

Colisage: 40p/13,2kg | s/c : 20p
Carton : 40p/ 29 lbs | i/c : 20p

MINA L

Large portable LED lamp (7 inches) / Lampe LED portable large (17 cm)

MINA L

Design by Manuela Simonelli & Andrea Quaglio



- LAMPE AVEC 9 COULEURS DE LED**

LAMP WITH 9 COLORS
- VARIATEUR D'INTENSITÉ**

DIMMER
- JUSQU'À 24 HEURES D'AUTONOMIE**

UP TO 24 HOURS BATTERY LIFE
- PORT DE CHARGE USB-C**

USB-C CHARGING PORT
- RECHARGEABLE PAR INDUCTION**

WIRELESSLY RECHARGEABLE
- ADAPTÉE À UN USAGE EXTÉRIEUR (IPX4)**

SUITABLE FOR OUTDOOR USE (IPX4)
- FINITION ALUMINIUM**

ALUMINUM FINISHING

Lampe LED portable large - Lumière blanche froide ou chaude + 7 couleurs - Puissance lumineuse maximale : 65 lm - Contrôle de la lumière par pression - Variateur d'intensité - Résistance à l'eau IPX4 - Autonomie : jusqu'à 24h (testée à 75% de luminosité, 22°C de température ambiante) - Temps de charge : 3h - Rechargeable sur port USB-C (câble inclus) ou par induction. Matériaux : Aluminium - ABS.

Large portable LED lamp - Cool or warm white light + 7 colors - Maximum light output: 65 lm - Push activation light - Dimmer - Water resistant IPX4 - Battery life: up to 24h (tested at 75% brightness, 22°C ambient indoor temperature) - Charging time: 3h - Rechargeable on USB-C port (cable included) or wirelessly - Material: Aluminum - ABS.



Ø14 x 17 cm | P.Brut : 600 g
5.5 x 6.73" | P.Brut : 1.33 lbs



Colisage : 12p/8,0 kg
Carton : 12p/17,64 lbs

MINA L AUDIO

Portable LED lamp with 360° built-in Bluetooth® speaker
Lampe LED portable avec enceinte Bluetooth® à 360° intégrée

MINA L AUDIO

Design by Manuela Simonelli & Andrea Quaglio



AWARDS

reddot winner 2022

GOOD DESIGN



- LAMPE AVEC 9 COULEURS DE LED**
 LAMP WITH 9 LED COLORS
- ENCEINTE BLUETOOTH®**
 BLUETOOTH® SPEAKER
- SON 360°**
 360° SOUND
- VARIATEUR D'INTENSITE**
 DIMMER
- JUSQU'À 24 HEURES D'AUTONOMIE**
 UP TO 24 HOURS BATTERY LIFE
- PORT DE CHARGE USB-C**
 USB-C CHARGING PORT
- RECHARGEABLE PAR INDUCTION**
 WIRELESSLY RECHARGEABLE
- FINITION ALUMINIUM**
 ALUMINIUM FINISHING

Lampe LED audio portable large - Lumière blanche froide ou chaude + 7 couleurs - Puissance lumineuse maximale : 65 lm - Contrôle de la lumière par pression - Variateur d'intensité - Enceinte Bluetooth® 5W - Autonomie d'éclairage : jusqu'à 24h (testée à 75% de luminosité, 22°C de température ambiante) - Temps de charge : 3h - Rechargeable sur port USB-C (câble inclus) ou par induction - Matériaux : Aluminium - ABS.

Large portable audio LED lamp - Cool or warm white light + 7 colors - Maximum light output: 65 lm - Push activation light - Dimmer - Light battery life: up to 24h (tested at 75% brightness, 22°C ambient indoor temperature) Charging time: 3h - Rechargeable on USB-C port (cable included) or wirelessly. Material: Aluminum - ABS.

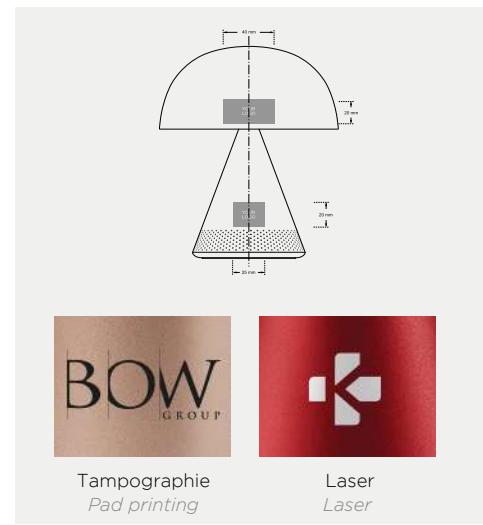

Ø14 x 17 cm | P.Brut : 614 g
Ø5.5 x 6.7" | G.W. : 1.35 lbs

Colisage: 12p/8,4 kg
Carton : 12p/ 18.52 lbs

LUMA S

Infinitely pairable LED lamp (3 inches) / Lampe LED connectable à l'infini (8 cm)

LUMA S

Design by Manuela Simonelli & Andrea Quaglio



- LAMPE AVEC 9 COULEURS DE LED**

LAMP WITH 9 LED COLORS
- CONNECTABLE À L'INFINI**

INFINITELY PAIRABLE
- VARIATEUR D'INTENSITÉ**

DIMMER
- JUSQU'À 8 H D'AUTONOMIE**

UP TO 8 H BATTERY LIFE
- PORT DE CHARGE USB-C**

USB-C CHARGING PORT
- ADAPTÉE À UN USAGE EXTÉRIEUR (IPX4)**

SUITABLE FOR OUTDOOR USE (IPX4)
- FINITION ALUMINIUM**

ALUMINUM FINISHING

Lampe LED connectable à l'infini - Lumière blanche froide ou chaude + 7 couleurs - Puissance lumineuse maximale : 45 lm - Variateur d'intensité - Contrôle tactile - Résistante à l'eau (IPX4) - Autonomie : Jusqu'à 8h (testée à 75% de luminosité) - Rechargeable sur port USB-C (câble inclus) - Temps de charge : 2h - Matériaux: Aluminium - ABS.

Infinitely pairable LED lamp - Cool or warm white light + 7 colors - Maximum light output: 45 lm - Dimmer - Touch control - Water resistant (IPX4) - Battery life: Up to 8h (tested at 75% brightness) - Rechargeable via USB-C port (cable included) - Charge time: 2h - Material: Aluminum - ABS.

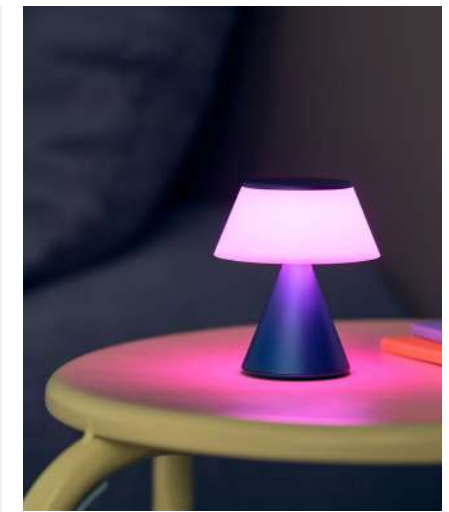
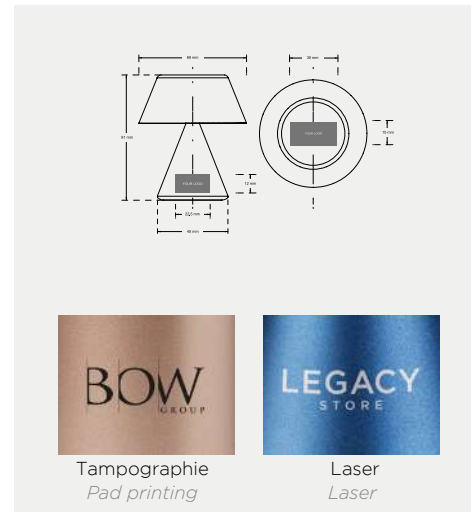

Ø6.9 x 8.1 cm / P. Brut: 150 g
Ø2.72 x 3.19" / G.W: 0.33 lbs

Colisage: 40 pcs / Env. 7 kg
Carton: 40 pcs / Approx. 15.43 lbs

LUMA M

Infinitely pairable LED lamp (4 inches) / *Lampe LED connectable à l'infini (11 cm)*

LUMA M

Design by Manuela Simonelli & Andrea Quaglio



- LAMPE AVEC 9 COULEURS DE LED**



LAMP WITH 9 LED COLORS
- CONNECTABLE À L'INFINI**



INFINITELY PAIRABLE
- VARIATEUR D'INTENSITÉ**



DIMMER
- JUSQU'À 24 H D'AUTONOMIE**



UP TO 24 H BATTERY LIFE
- PORT DE CHARGE USB-C**



USB-C CHARGING PORT
- RECHARGEABLE PAR INDUCTION**



WIRELESSLY RECHARGEABLE
- ADAPTÉE À UN USAGE EXTÉRIEUR (IPX4)**



SUITABLE FOR OUTDOOR USE (IPX4)
- FINITION ALUMINIUM**



ALUMINUM FINISHING

Lampe LED connectable à l'infini - Lumière blanche froide ou chaude + 7 couleurs - Puissance lumineuse maximale : 65 lm - Variateur d'intensité - Contrôle tactile - Résistante à l'eau (IPX4) - Autonomie : Jusqu'à 24h (testée à 75% de luminosité) - Rechargeable sur port USB-C (câble inclus) ou par induction - Temps de charge : 3h - Matériaux: Aluminium - ABS.

Infinitely pairable LED lamp - Cool or warm white light + 7 colors - Maximum light output: 65 lm - Dimmer - Touch control - Water resistant (IPX4) - Battery life: Up to 24h (tested at 75% brightness) - Rechargeable via USB-C port (cable included) or wirelessly - Charge time: 3h - Material: Aluminum - ABS.



Ø9,3 x 10,8 cm - P.Brut : 281 g
Ø3.66 x 4.25" - G.W: 0.62 lbs

Colisage : 20p/6.1 kg
Carton: 20p/13.45 lbs

LUMA L

Infinitely pairable LED lamp (7 inches) / *Lampe LED connectable à l'infini (17 cm)*



- LAMPE AVEC 9 COULEURS DE LED**
LAMP WITH 9 LED COLORS
- 120 LUMENS DE LUMINOSITÉ**
120 LUMENS BRIGHTNESS
- CONNECTABLE À L'INFINI**
INFINITELY PAIRABLE
- VARIATEUR D'INTENSITÉ**
DIMMER
- JUSQU'À 14 H D'AUTONOMIE**
UP TO 14 H BATTERY LIFE
- PORT DE CHARGE USB-C**
USB-C CHARGING PORT
- RECHARGEABLE PAR INDUCTION**
WIRELESSLY RECHARGEABLE
- ADAPTÉE À UN USAGE EXTÉRIEUR (IPX4)**
SUITABLE FOR OUTDOOR USE (IPX4)
- FINITION ALUMINIUM**
ALUMINIUM FINISHING



Colors on request / *Couleurs sur demande*

LUMA L

Design by Manuela Simonelli & Andrea Quaglio



Lampe LED connectable à l'infini - Lumière blanche froide ou chaude + 7 couleurs - Puissance lumineuse maximale : 120 lm - Variateur d'intensité - Contrôle tactile - Résistante à l'eau (IPX4) - Autonomie : Jusqu'à 14h (testée à 75% de luminosité) - Rechargeable sur port USB-C (câble inclus) ou par induction - Temps de charge : 4h - Matériaux: Aluminium - ABS.

Infinitely pairable LED lamp - Cool or warm white light + 7 colors - Maximum light output: 120 lm - Dimmer - Touch control - Water resistant (IPX4) - Battery life: Up to 14h (tested at 75% brightness) - Rechargeable via USB-C port (cable included) or wirelessly - Charge time: 4h - Material: Aluminum - ABS.

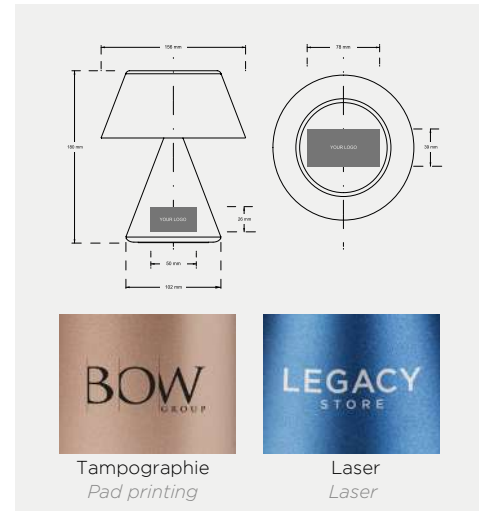

Ø15,6 x 17 cm / P. Brut: 750 g
Ø6.14 x 7.09" / G.W: 1.65 lbs



Colisage: 12 pcs / Env. 10 kg
Carton: 12 pcs / Approx. 22.04 lbs

LUMA XL

Infinitely pairable LED lamp (10 inches) / Lampe LED connectable à l'infini (25 cm)

LUMA XL

Design by Manuela Simonelli & Andrea Quaglio



- LAMPE AVEC 9 COULEURS DE LED**
LAMP WITH 9 LED COLORS
- 200 LUMENS DE LUMINOSITÉ**
200 LUMENS BRIGHTNESS
- CONNECTABLE À L'INFINI**
INFINITELY PAIRABLE
- VARIATEUR D'INTENSITÉ**
DIMMER
- JUSQU'À 10 H D'AUTONOMIE**
UP TO 10 H BATTERY LIFE
- PORT DE CHARGE USB-C**
USB-C CHARGING PORT
- RECHARGEABLE PAR INDUCTION**
WIRELESSLY RECHARGEABLE
- ADAPTÉE À UN USAGE EXTÉRIEUR (IPX4)**
SUITABLE FOR OUTDOOR USE (IPX4)
- FINITION ALUMINIUM**
ALUMINIUM FINISHING

Lampe LED connectable à l'infini - Lumière blanche froide ou chaude + 7 couleurs - Puissance lumineuse maximale : 200 lm - Variateur d'intensité - Contrôle tactile - Résistante à l'eau (IPX4) - Autonomie : Jusqu'à 10h (testée à 75% de luminosité) - Rechargeable sur port USB-C (câble inclus) ou par induction - Temps de charge : 4h - Matériaux: Aluminium - ABS.

Infinitely pairable LED lamp - Cool or warm white light + 7 colors - Maximum light output: 200 lm - Dimmer - Touch control - Water resistant (IPX4) - Battery life: Up to 10h (tested at 75% brightness) - Rechargeable via USB-C port (cable included) or wirelessly - Charge time: 4h - Material: Aluminum - ABS.



Colors on request / Couleurs sur demande

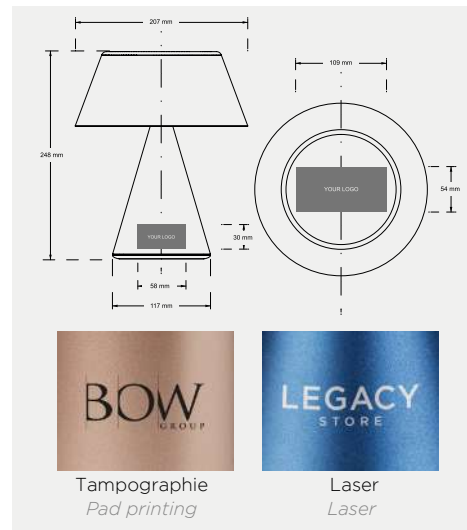

Ø20.7 x 24.8 cm / P. Brut: 990 g
Ø8.15 x 9.76" / G.W: 2.18 lbs

Colisage: 6 pcs / Env. 7 kg
Carton: 6 pcs / Approx. 15.43 lbs

HORIZON HANGING LAMP

Multi-color outdoor LED lamp / Lampe portable d'extérieur à LED multicolore



- LAMPE AVEC 9 COULEURS DE LED**



LAMP WITH 9 LED COLORS
- VARIATEUR D'INTENSITÉ**



DIMMER
- CONTRÔLE TACTILE**



TOUCH CONTROLS
- JUSQU'À 12 HEURES D'AUTONOMIE**



UP TO 12 HOURS BATTERY LIFE
- RECHARGEABLE PAR USB-C**



RECHARGEABLE VIA USB-C
- ADAPTÉE À UN USAGE EXTÉRIEUR (IPX4)**



SUITABLE FOR OUTDOOR USE (IPX4)
- POIGNÉE EN ALUMINIUM**



ALUMINUM HANDLE



D O1 LB1 X

HORIZON HANGING LAMP

Design by natacha.sacha.



Lampe LED nomade avec poignée - Lumière blanche froide ou chaude + 7 couleurs d'éclairage - Puissance lumineuse maximale : 65 lm - Contrôles tactiles - Variateur d'intensité - Résistance à l'eau IPX4 - Autonomie : jusqu'à 12h - Temps de charge : 3h - Rechargeable via USB-C (câble inclus). Matériaux : Aluminium - ABS.

Hanging portable LED lamp - Cool or warm white light + 7 colors - Maximum light output: 65 lm - Touch activation light - Dimmer - Water resistant IPX4 - Battery life: up to 12h - Charging time: 3h - Rechargeable via USB-C port (cable included). Material: Aluminum - ABS.

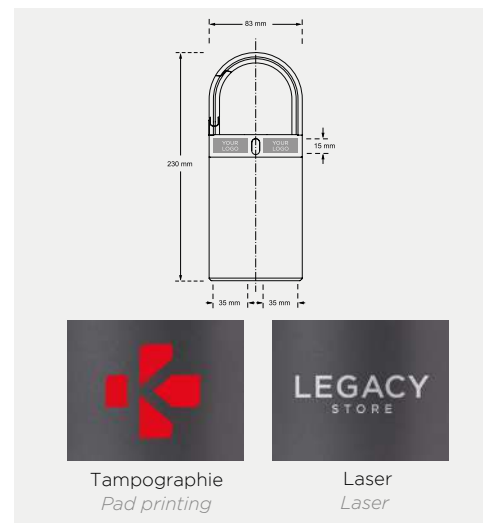

20 x 8,3 x 6,2 cm | P. Brut : 350 g
7.87 x 3.27 x 2.45" | G.W: 0.77 lbs



Colisage : 12 p/6.2 kg
Carton: 12 p/ 13.66 lbs

BOLLA+

Multi-color outdoor LED lamp / Lampe portable d'extérieur à LED multicolore

BOLLA+

Design by Claudio Gatto



- LAMPE AVEC 9 COULEURS DE LED**
 LAMP WITH 9 LED COLORS
- VARIATEUR D'INTENSITÉ**
 DIMMER
- JUSQU'À 8 H D'AUTONOMIE**
 UP TO 8 H BATTERY LIFE
- RECHARGEABLE PAR USB-C**
 RECHARGEABLE VIA USB-C
- ADAPTÉE À UN USAGE EXTÉRIEUR (IPX4)**
 SUITABLE FOR OUTDOOR USE (IPX4)

Lampe LED multiposition - Usage intérieur/extérieur - Lumière blanche froide ou chaude + 7 couleurs - Puissance lumineuse maximale : 25 lm - Contrôle tactile - Mémoire de sauvegarde de la dernière couleur sélectionnée - Autonomie : jusqu'à 8h - Temps de charge : 2h - Rechargeable sur port USB-C (câble inclus) - Résistance à l'eau : IPX4 - Matériaux : Silicone - ABS.

Multi-position LED lamp - Indoor/outdoor use - Cool or warm white light + 7 colors - Maximum light output: 25 lm - Touch control - Backup memory of the last color selected - Battery life: up to 8h - Charging time: 2h Rechargeable on USB-C port (cable included) - Water resistance: IPX4 .Material: Silicone - ABS.



DB9

D9

W

N

X9

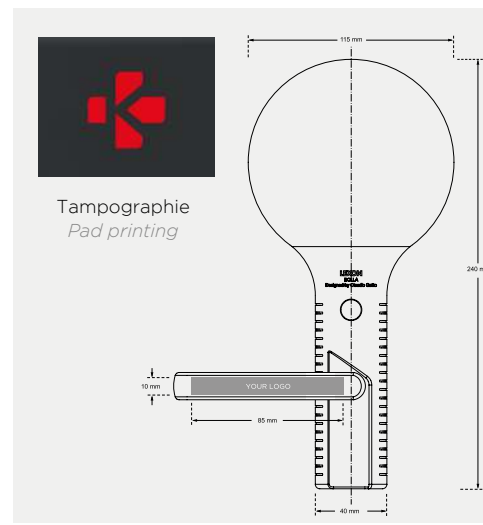

Ø11,5 x 28,2 cm | P. Brut : 318 g
Ø4,5 x 11,1" | G.W : 0.7 lbs



Colisage : 20 p/11,6 kg | s/c: 5p
Carton : 20p/ 25,5 lbs | i/c : 5p

ORBE

Portable LED lamp with moving head / Lampe LED portable avec tête amovible

ORBE

Design by Nelson Fossey



AWARD



reddot winner 2023



- LAMPE AVEC 9 COULEURS DE LED

LAMP WITH 9 LED COLORS
- 100 LUMENS DE LUMINOSITÉ

100 LUMENS BRIGHTNESS
- TÊTE MAGNÉTIQUE ROTATIVE & DETACHABLE

ROTATING & DETACHABLE MAGNETIC HEAD
- VARIATEUR D'INTENSITÉ

DIMMER
- JUSQU'À 48 H D'AUTONOMIE

UP TO 48 H BATTERY LIFE
- RECHARGEABLE PAR USB-C

RECHARGEABLE VIA USB-C
- ADAPTÉE À UN USAGE EXTÉRIEUR (IPX4)

SUITABLE FOR OUTDOOR USE (IPX4)



Lampe LED portable avec tête rotative et amovible - 9 couleurs d'éclairage - Puissance lumineuse maximale : 100 lm - Variateur d'intensité - Jusqu'à 48 heures d'éclairage - Temps de charge : 5h - Rechargeable par USB-C - Convient pour une utilisation en extérieur (IPX4) - Matériaux : ABS - PP.

Portable LED lamp with moving and detachable head - 9 LED colors - Maximum light output: 100 lm - Dimmer - Up to 48 hours of illumination - Charging time: 5h - Rechargeable via USB-C - Suitable for outdoor use (IPX4). Material: PP - ABS.

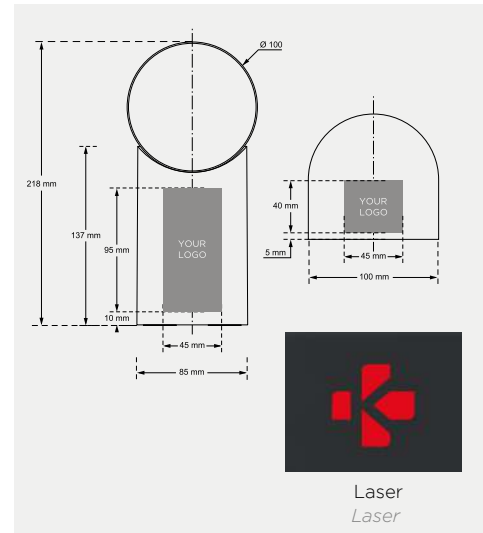

Laser
Laser

Ø10 x 21,8 cm - P.Brut : 800 g
Ø3.94 x 8.27"- G.W: 1.67 lbs



Colisage : 12p/10.7 kg
Carton: 12p/23.6 lbs

BUBBLE LAMP

Desk lamp with built-in wireless charger
Lampe de bureau avec chargeur à induction intégré



- LAMPE AVEC 9 COULEURS DE LED**
LAMP WITH 9 LED COLORS
- 150 LUMENS DE LUMINOSITÉ**
150 LUMENS BRIGHTNESS
- DIFFUSEUR EN VERRE OPALE**
FROSTED GLASS DIFFUSER
- VARIATEUR D'INTENSITÉ**
DIMMER
- CHARGEUR À INDUCTION RAPIDE 15W**
15W FAST WIRELESS CHARGER
- CERTIFIÉ Qi**
Qi CERTIFIED
- JUSQU'À 6 H D'AUTONOMIE**
UP TO 6 H BATTERY LIFE
- FINITION ALUMINIUM**
ALUMINIUM FINISHING



BUBBLE LAMP

Design by Alain Berteau



Lampe de bureau avec chargeur à induction intégré - Lumière blanche froide ou chaude + 7 couleurs d'éclairage - Puissance lumineuse maximale : 150 lm - Variateur d'intensité - Contrôle tactile - Compatible avec tous les appareils dotés de la technologie Qi - Autonomie : Jusqu'à 6h - Temps de charge : 3h - Double port USB-C pour charger et recharger - Matériaux : Aluminium - ABS - Verre.

Desk lamp with built-in wireless charger - Cold or warm white light + 7 lighting colors - Maximum light output: 150 lm - Dimmer - Touch control - Compatible with all Qi-enabled devices - Battery life: Up to 6 hours - Charging time: 3h - Dual USB-C port for charging and recharging. Materials: Aluminum - ABS - Glass.

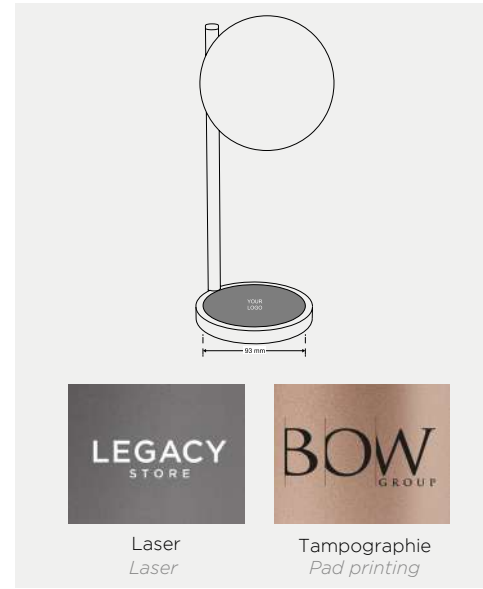

Ø12 x 29,6 cm - P.Brut : 813 g
Ø4.72 x 11.4" - G.W: 1.79 lbs



Colisage : 8p / 8.1 kg
Carton: 8p / 17.86 lbs

LANTERN

Portable lamp with built-in wireless charger
Lampe portable avec chargeur à induction intégré

AWARD



reddot winner 2023



- LAMPE AVEC 9 COULEURS DE LED**
LAMP WITH 9 LED COLORS
- 100 LUMENS DE LUMINOSITÉ**
100 LUMENS BRIGHTNESS
- VARIATEUR D'INTENSITÉ**
DIMMER
- CONTRÔLE TACTILE**
TOUCH CONTROLS
- BATTERIE EXTERNE 5 000 mAh**
5 000 mAh POWER BANK
- CHARGEUR À INDUCTION**
WIRELESS CHARGER
- JUSQU'À 8 H D'AUTONOMIE**
UP TO 8 H BATTERY LIFE
- ADAPTÉE À UN USAGE EXTÉRIEUR (IPX4)**
SUITABLE FOR OUTDOOR USE (IPX4)



LANTERN

Design by Alain Berteau



Un design contemporain pour un objet intemporel - Une solution d'éclairage LED élégante et contrôlée tactilement - Puissance lumineuse maximale : 100 lm - Un éclairage mobile intérieur et extérieur combiné à un chargeur par induction certifié Qi pour les appareils compatibles - Batterie intégrée de 5000 mAh et des LED RVB à 9 couleurs - Utilisable en extérieur classée IPX4 - Autonomie : 8h pour l'éclairage seul - Temps de charge: 4h - Connexion : USB Type-C (câble inclus) - Alimentation : il est recommandé d'utiliser l'adaptateur secteur Quick Charge 3.0 (non inclus) ou un adaptateur secteur DC 9 V/2 A (non inclus). Matériaux: Cuir synthétique - ABS.

Contemporary design for a timeless object - Embedding elegant and touch-controlled LED lighting solution - Maximum light output: 100 lm - Offering outdoor and indoor mobile illumination combined with a Qi certified wireless charger for enabled devices - 5000 mAh battery built-in and 9 colors RGB LEDs - Outdoor friendly with IPX4 rating - Battery life: Up to 8h for lighting mode only - Charging time: 4h - Connection: USB Type-C (cable included) - Power supply: recommend to use with Quick Charge 3.0 Power Adapter (not included) or a DC 9V/2A power Adapter (not included). Material: Synthetic leather - ABS.

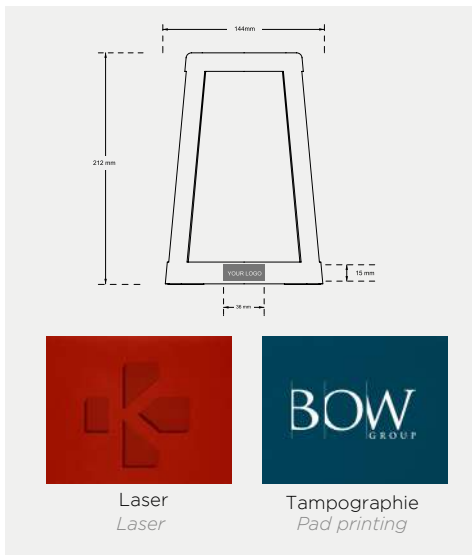

21,2 x 14,4 cm | P. Brut : 650 g
5,6 x 8,3" | G.W: 1,43 lbs

Colisage : 6 p/5 kg
Carton: 6 p/ 11 lbs

TERRACE+

3-in-1 LED lamp with built-in speaker & power bank
Lampe LED 3-en-1 avec enceinte & batterie intégrées



TERRACE+

Design by Anne Klepper & Elise Berthier



Lampe LED 3-en-1 avec enceinte & batterie intégrées - Lumière blanche froide ou chaude + 7 couleurs - Effets lumineux d'ambiance - Puissance lumineuse maximale : 150 lm - Variateur d'intensité - Contrôle tactile - Résistante à l'eau (IPX4) - Connecteur USB-C à double sens + port 2-USB A pour recharger n'importe quel appareil - Autonomie d'éclairage : jusqu'à 24h (testée à 75% de luminosité) - Rechargeable sur port USB-C (câble inclus) - Matériaux : Métal - ABS. Marquage conseillé : laser - tampographie.

3-In-1 LED lamp with built-in speaker & power bank - Cool or warm white light + 7 colors - Special lighting effect - Maximum light output: 150 lm - Dimmer - Touch control - Water-resistant (IPX4) - Two-way USB-C connector + 2-USB A port for recharging any device - Light battery life: up to 24h (tested at 75% brightness) - Rechargeable on USB-C port (cable included) - Material: Metal - ABS. Suggested branding: laser - pad printing.

- LAMPE AVEC 9 COULEURS DE LED
- ENCEINTE BLUETOOTH®
- 150 LUMENS DE LUMINOSITÉ
- SON 360°
- VARIATEUR D'INTENSITÉ
- BATTERIE EXTERNE 4 000 mAh
- 2X PORT USB-A POUR RECHARGER
- PORT USB-C POUR CHARGER ET RECHARGER
- ADAPTÉE À UN USAGE EXTÉRIEUR (IPX4)

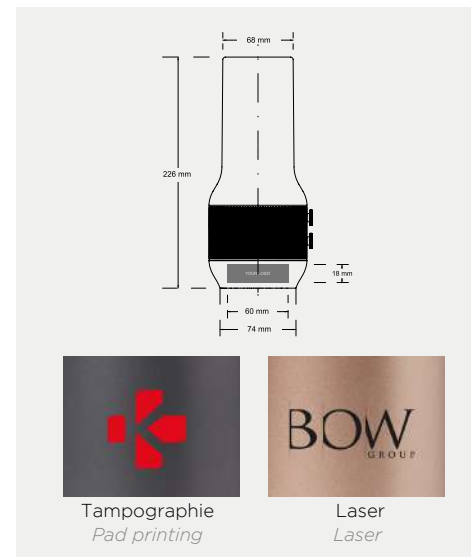

Color on request / Couleur sur demande

Ø10 x 22,6 cm / P. Brut: 800 g
Ø3.94 x 8.89" / G.W: 1.76 lbs

Colisage: 12 pcs / Env. 11 kg
Carton: 12 pcs / Approx. 24.25 lbs

STELI

Infinitely pairable table lamp / Lampe de table connectable à l'infini



- LAMPE AVEC 9 COULEURS DE LED**
LAMP WITH 9 LED COLORS
- 120 LUMENS DE LUMINOSITÉ**
120 LUMENS BRIGHTNESS
- CONNECTABLE À L'INFINI**
INFINITELY PAIRABLE
- VARIATEUR D'INTENSITÉ**
DIMMER
- JUSQU'À 10 H D'AUTONOMIE**
UP TO 10 H BATTERY LIFE
- RECHARGEABLE PAR USB-C**
RECHARGEABLE VIA USB-C
- RECHARGEABLE PAR INDUCTION**
WIRELESSLY RECHARGEABLE
- ADAPTÉE À UN USAGE EXTÉRIEUR (IPX4)**
SUITABLE FOR OUTDOOR USE (IPX4)
- FINITION ALUMINIUM**
ALUMINUM FINISHING



STELI

Design by Manuela Simonelli & Andrea Quaglio

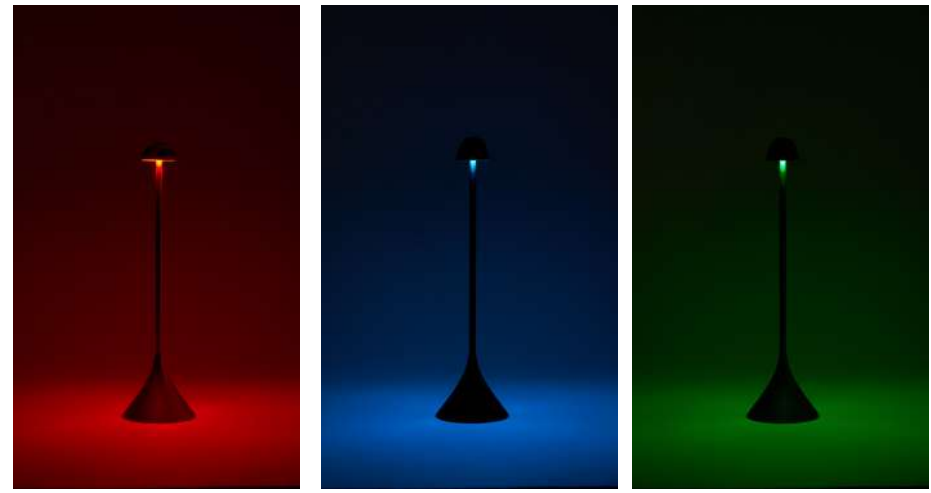

Lampe de table connectable à l'infini - Lumière blanche froide ou chaude + 7 couleurs - Puissance lumineuse maximale : 120 lm - Variateur d'intensité - Commande tactile - Résistante à l'eau (IPX4) - Autonomie : Jusqu'à 10h (testée à 75% de luminosité) - Rechargeable sur port USB-C (câble inclus) ou par induction - Temps de charge : 3h. Matériaux: Aluminium-ABS.

Infinitely pairable table lamp - Cool or warm white light + 7 colors - Maximum light output: 120 lm - Dimmer - Touch control - Water-resistant (IPX4) - Battery life: Up to 10h (tested at 75% brightness) - Rechargeable via USB-C port (cable included) or wirelessly - Charge time: 3h - Material: Aluminum - ABS.

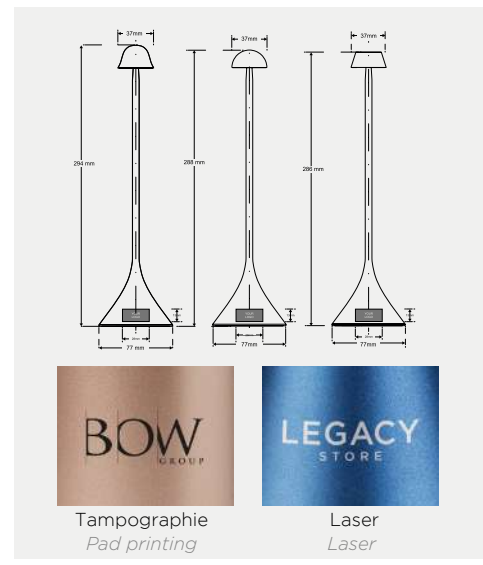

Ø3.7 x 28.6 x Ø7.7 cm / P. Brut: 270 g
Ø1.46 x 11.26 x Ø3.063" / G.W: 0.59 lbs

Colisage: 20 pcs / Env. 6.2 kg
Carton: 20 pcs / Approx. 13.67 lbs

CONIC LAMP

Spherical portable LED Lamp / Lampe LED portable sphérique

CONIC LAMP

Design by Lidia Gomez



- LAMPE AVEC 9 COULEURS DE LED**



LAMP WITH 9 LED COLORS
- VARIATEUR D'INTENSITÉ**



DIMMER
- JUSQU'À 12 H D'AUTONOMIE**



UP TO 12 H BATTERY LIFE
- RECHARGEABLE PAR USB-C**



RECHARGEABLE VIA USB-C
- CONTRÔLEUR ROTATIF POUR LE RÉGLAGE DE L'ÉCLAIRAGE**



ROTARY CONTROLLER FOR LIGHTING ADJUSTMENT
- ADAPTÉE À UN USAGE EXTÉRIEUR (IPX4)**



SUITABLE FOR OUTDOOR USE (IPX4)
- FINITION ALUMINIUM**



ALUMINIUM FINISHING

Lampe LED portable sphérique - Lumière blanche froide ou chaude + 7 couleurs - Variateur d'intensité - Système de contrôle rotatif pour les commandes d'éclairage - Résistante à l'eau (IPX4) - Autonomie : Jusqu'à 12h (testée à 75% de luminosité) - Rechargeable sur port USB-C (câble inclus) - Temps de charge : 4h - Matériaux : Aluminium-ABS.

Spherical portable LED lamp - Cool or warm white light + 7 colors - Dimmer - Rotary control system for lighting commands - Water resistant (IPX4) - Battery life: Up to 12h (tested at 75% brightness) - Rechargeable on USB-C port (cable included) - Charge time: 4h - Material: Aluminum - ABS.

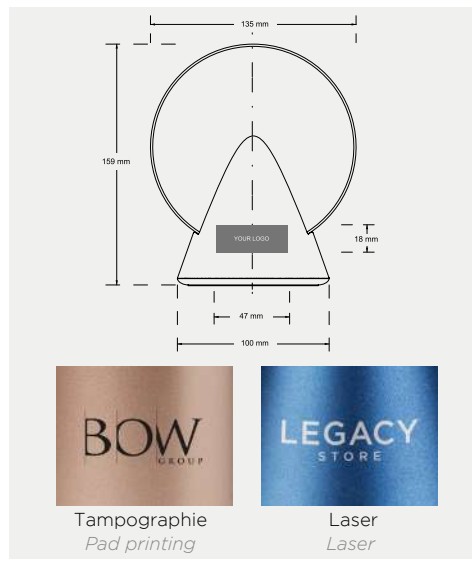

Ø13.5 x 15.9 cm / P. Brut: 440 g
Ø5.31 x 6.26" / G.W: 0.97 lbs

Colisage: 12 pcs / Env. 7 kg
Carton: 12 pcs / Approx. 15.43 lbs

LH99

NEW

MIMI

Clip-on flexible reading lamp / Liseuse flexible avec clip
Design by Manuela Simonelli & Andrea Quaglio



LAMPE AVEC 9
COULEURS DE LED



LAMP WITH 9
COLORS

BRAS
FLEXIBLE



FLEXIBLE
ARM

CLIP
INTÉGRÉ



BUILT-IN
CLIP

VARIATEUR
D'INTENSITÉ



DIMMER

JUSQU'À 12 H
D'AUTONOMIE



UP TO 12 H
BATTERY LIFE

RECHARGEABLE
PAR USB-C



RECHARGEABLE
VIA USB-C



Liseuse flexible avec clip - Angle réglable - Lumière blanche froide ou chaude + 7 couleurs - Variateur d'intensité - Contrôle tactile - Autonomie : jusqu'à 12h (testé à 75% de luminosité) - Rechargeable sur port USB-C (câble inclus) - Temps de charge : 2h - Matériaux : Aluminium - ABS - Silicone. Marquage conseillé : tampographie.

Clip-on flexible reading lamp - Adjustable angle - Cool or warm white light + 7 colors - Dimmer - Touch control - Battery life: Up to 12h (tested at 75% brightness) - Rechargeable on USB-C port (cable included) - Charging time: 2h - Material: Aluminum - ABS - Silicone. Suggested branding: pad print.

Lampe: Ø4.7 x 21.1 cm - Support: 7.2 x 4.5 cm / P. Brut: 270 g
Lamp: Ø1.85 x 8.31" - Stand: 2.83 x 1.77" / G.W: 0.59 lbs

Colisage: 20 pcs / Env. 6.2 kg
Carton: 20 pcs / Approx. 13.67 lbs

LH102

NEW

HELIA

Bi-directional LED lamp / Lampe LED bi-directionnelle
Design by Stefanie Kay



LAMPE LED
MULTIFONCTIONNELLE



MULTIFUNCTIONAL
LED LAMP

REPRODUCTION DES
CYCLES NATURELS DE
LA LUMIÈRE



NATURAL LIGHT
CYCLES EFFECT

LAMPE AVEC 9
COULEURS DE LED



LAMP WITH 9
COLORS

VARIATEUR
D'INTENSITÉ



DIMMER

JUSQU'À 18 H
D'AUTONOMIE



UP TO 18 H
BATTERY LIFE

RECHARGEABLE
PAR USB-C



RECHARGEABLE
VIA USB-C

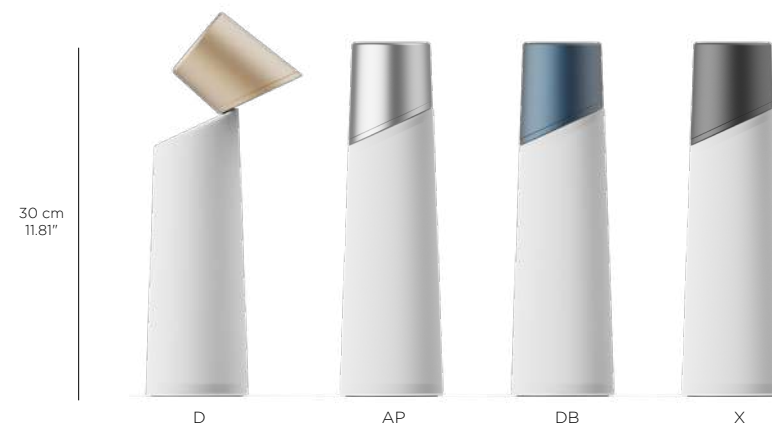

Lampe LED bi-directionnelle - lampe de lecture avec tête pivotante - lampe d'ambiance avec lumière blanche froide ou chaude + 7 couleurs - Reproduction des cycles naturels de la lumière (rythme circadien) - Variateur d'intensité - Commandes tactiles - Autonomie jusqu'à 18 heures - Rechargeable sur port USB-C (câble inclus) - Temps de charge 3h - Matériau : ABS. Marquage conseillé : tampographie.

Bi-directional LED lamp - reading lamp with swivel head - mood lamp with cool or warm white light + 7 colors - Natural light reproduction function (circadian rhythm) - Dimmer - Touch controls - Up to 18 hour battery life - Rechargeable via USB-C port (cable included) - Charging time 3h - Material: ABS. Suggested branding: pad print.

Ø8.7 x 32 cm / P. Brut: 500 g
Ø3.42 x 12.59" / G.W: 1.10 lbs

Colisage: 12 pcs / Env. 6.6 kg
Carton: 12 pcs / Approx. 14.55 lbs

CARE

PRENDRE SOIN DE SOI

CARE *PRENDRE SOIN DE SOI*



HORIZON COLLECTION



DIFFUSER



DISPENSER



SAFETOUCH



NEW MAGSPRAY



THERMO
BOTTLE

NOMADAY COLLECTION



UV
STRAW



NEW UV
DRINK



NEW UV
PICNIC SET



NEW PILLBOX



THERMO
BOTTLE

OBLIO COLLECTION



OBLIO



BOX



NEW DUO



NEW WALLET

ZEN COLLECTION



MANO



NEW DIVA



NEW ROMINO



NEW ARIA



NEW BIRDY

HORIZON DIFFUSER

Aromatherapy humidifier and mist maker / Humidificateur et brumisateuse aromatherapique

HORIZON DIFFUSER

Design by natacha.sacha



DIFFUSION SILENCIEUSE
AVEC TECHNOLOGIE
ULTRASONIQUE



SILENT DIFFUSION
WITH ULTRASONIC
TECHNOLOGY

BRUME FRAÎCHE
INOFFENSIVE



COOL MIST SAFE
FOR USE

JUSQU'À 12H
D'AUTONOMIE



UP TO 12 HOURS
BATTERY LIFE

CAPACITÉ DU
RÉSERVOIR 1L



TANK CAPACITY
34 fl.oz

ARRÊT AUTOMATIQUE EN
CAS DE MANQUE D'EAU



AUTOMATIC SHUT-OFF
WHEN WATER TANK
IS EMPTY

RECHARGEABLE
PAR USB-C



RECHARGEABLE
VIA USB-C



D

O1

LBI

X



Diffuseur d'huiles essentielles et humidificateur à brume - 12h d'autonomie continue - capacité du réservoir 1 L - Cycle de diffusion réglable - arrêt automatique lorsque le réservoir d'eau est vide - Alimentation : sur port USB-C (câble inclus). Matériaux : Aluminium/ABS.

Essential oil diffuser and mist humidifier - 12h continuous mist - 33 oz tank capacity - Adjustable diffusion cycle - waterless auto-off - Power supply: on USB-C port (cable included). Material: Aluminum / ABS.

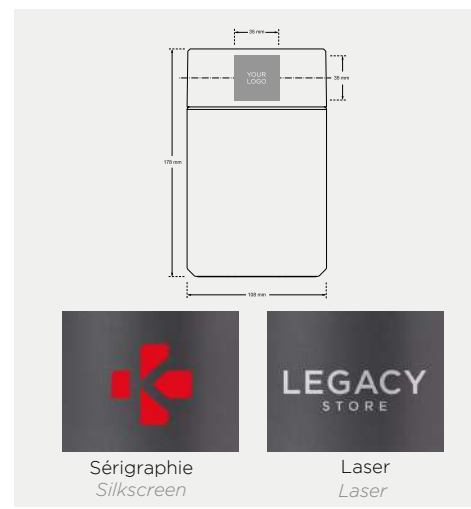

Ø10.8 x 17.8 cm | P. Brut: 530 g
Ø4.25 x 7.01" | G.W: 1,17 lbs



Colisage : 12p/8 kg
Carton: 12p/ 18 lbs

HORIZON DISPENSER

Automatic gel or soap dispenser / Distributeur automatique de gel ou de savon



DISTRIBUTEUR DE GEL
SANS CONTACT



CONTACTLESS GEL
DISPENSER

DÉTECTION
AUTOMATIQUE DES MAINS



AUTOMATIC HAND
DETECTION

CAPACITÉ
400 ML



13.5 oz
CAPACITY

FONCTIONNE AVEC
DU SAVON LIQUIDE



WORKS WITH
LIQUID SOAP

JUSQUA 6 MOIS
D'AUTONOMIE



UP TO 6 MONTHS
BATTERY LIFE

PORT DE
CHARGE USB-C



USB-C
CHARGING PORT



D

O1

LB1

X

HORIZON DISPENSER

Design by natacha.sacha



Distributeur automatique de gel hydroalcoolique pour maison et bureau - Fonctionne avec du savon liquide - Batterie rechargeable intégrée - Grand réservoir d'une capacité de 400ml pour une utilisation quotidienne - Débit de la pompe réglable avec valve anti-goutte - Autonomie : 6 mois - Temps de charge: 4h - Alimentation: sur port USB-C (câble inclus) - Matériaux : Aluminium - ABS.

Home & office automatic hydroalcoholic gel dispenser - Works with liquid soap - Built-in rechargeable battery - Large 400ml / 13.5oz tank capacity for daily usage - Adjustable pump flow with no-drip valve - Battery life: 6 month - Charging time: 4h. Power supply: on a USB Type-C port (cable included) - Material: Aluminum - ABS.

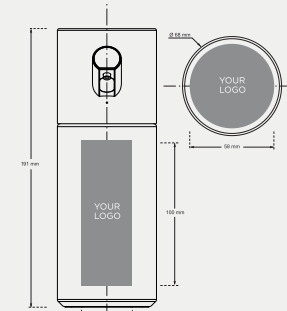

BOW
GROUP

Tampographie
Pad printing

LEGACY
STORE

Laser
Laser

Distributeur : Ø7.5 x 19.1 cm / P. Brut: 380 g
Dispenser: Ø2.95 x 7.52" / G.W: 0.83 lbs



Colisage: 20p / Env. 8.2 kg
Carton: 20p / Approx. 18.08 lbs

HORIZON SAFETOUCH

Contactless door opener & keyring / *Porte-clés & ouvre-porte sans contact*
Design by natacha.sacha



Crédit photo : @natacha.sacha.

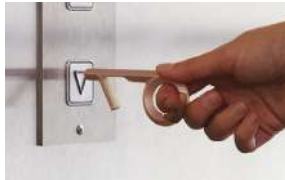

D

O1

LB1

X

Porte-clés & ouvre-porte sans contact - Stylet en silicone antibactérien - Presse-bouton pour ascenseur/distributeur/interrupteur - Crochet pour ouverture ou fermeture de robinets et pousser ou tirer des poignées de portes - Passe-doigt résistant avec mousqueton intégré pour l'accrocher à vos clés - Matériaux : Aluminium - Silicone. Marquage conseillé: laser - tampographie.

Contactless key ring & door opener - Antibacterial silicone stylus - Button presser for lift/ATM machine/switch - Hook for opening or closing taps and pushing or pulling door handles - Strong finger loop with integrated carabiner for hanging on your keys - Material: Aluminum - Silicone. Suggested branding: laser - pad print.

9 x 4 x 0.9 cm / P.Brut : 40 g
3.54 x 1.57 x 0.35" / G.W: 0.09 lbs

Colisage: 100p / 4.45 kg
Carton : 100p / 9.81 lbs

HORIZON MAGSPRAY

Hydroalcoholic spray with Magsafe / *Spray hydroalcoolique avec Magsafe*
Design by natacha.sacha



VAPORISATEUR
DE POCHE



POCKET
SPRAY

POUR GEL HYDROALCOOLIQUE
OU PARFUM



FOR HYDROALCOLIC GEL
OR PERFUME

FIXATION MAGNÉTIQUE -
COMPATIBLE MAGSAFE



MAGNETIC ATTACHMENT
MAGSAFE COMPATIBLE

RECHARGEABLE



REFILLABLE



D



O1



LB1



X

Vaporisateur de poche - Rechargeable - Contenant pour gel hydroalcoolique ou parfum - Capacité de 30ml - Fixation magnétique Magsafe - Matériaux : Aluminium-ABS. Marquage conseillé: laser - tampographie.

Pocket spray - Refillable - Container for hydroalcoholic gel or perfume - 30ml capacity - Magsafe magnetic attachment - Material: Aluminum - ABS. Suggested branding: laser - pad print.

9 x 6.2 x 1.2 cm / P. Brut: 90 g
3.54 x 0.39 x 2.37" / G.W: 0.19 lbs

Colisage: 60p / Env. 6 kg
Carton: 60p / Approx. 13.23 lbs

HORIZON THERMO BOTTLE

Vacuum insulated stainless steel bottle (17 fl. oz) / Bouteille isotherme en acier inoxydable (500 ml)

HORIZON THERMO BOTTLE

Design by natacha.sacha



- CAPACITÉ 500 ML**



17 FL. oz CAPACITY
- ISOLATION SOUS VIDE DOUBLE PAROI**



DOUBLE-WALL VACUUM INSULATION
- 24h FROID 12h CHAUD**



24h COLD 12h HOT
- ÉTANCHE**



LEAKPROOF
- MOUSQUETON INTÉGRÉ**



BUILT-IN CLIP
- ACIER INOXYDABLE 18/8**



18/8 STAINLESS STEEL
- SANS BPA**



BPA FREE
- POUR TOUTE BOISSON**



FOR ALL BEVERAGES

Élégante bouteille à double isolation pour conserver votre liquide froid ou chaud pendant une longue période - Sans BPA - capacité 500 ml - Conserve les liquides chauds pendant 12 heures et les liquides froids pendant 24 heures. Matériaux: Acier inoxydable - ABS.

Elegant double insulated bottle for keeping your liquid cold or hot for long period - BPA-free - 500 ml / 16.9 oz capacity - Keep hot liquids for 12 hours and cold for 24 hours. Material: Stainless steel - ABS.



D O1 LBI X



Tampographie
Pad printing

Ø7.6 x 24.5 cm | P. Brut : 400 g
Ø2.9 x 9.65" | G.W: 0.88 lbs



Colisage : 20 p/8.6 kg
Carton: 20 p/ 18.95 lbs

LL147

NOMADAY UV STRAW

Reusable & self-cleaning straw with UV-C sanitizing
Paille réutilisable et autonettoyante avec capuchon stérilisateur UV-C

AWARD



reddot winner 2022



LL156

NEW

NOMADAY UV PICNIC SET

Reusable cutlery set with UV-C sanitizer / *Set de couverts réutilisables avec stérilisateur UV-C*
 Design by Guillaume Delvigne



PAILLE RÉUTILISABLE

 REUSABLE STRAW

ADAPTÉ POUR LE VOYAGE

 SUITABLE FOR TRAVEL

LED UV ANTI-BACTÉRIENNE

 ANTI-BACTERIAL UV LED

ÉLIMINE 99,9% DES BACTÉRIES

 KILL 99.9% OF BACTERIAS

DÉSINFECTION AUTOMATIQUE ET COMPLÈTE EN 1 MIN

 AUTOMATIC & FULL SANITIZING IN 1 MIN

RECHARGEABLE PAR USB-C

 RECHARGEABLE VIA USB-C

COUVERTS RÉUTILISABLES EN ACIER INOXYDABLE

 REUSABLE STAINLESS STEEL CUTLERIES

ADAPTÉ POUR LE VOYAGE

 SUITABLE FOR TRAVEL

LED UV ANTI-BACTÉRIENNE

 ANTI-BACTERIAL UV LED

ÉLIMINE 99,9% DES BACTÉRIES

 KILL 99.9% OF BACTERIAS

DÉSINFECTION AUTOMATIQUE ET COMPLÈTE EN 1 MIN

 AUTOMATIC & FULL SANITIZING IN 1 MIN

RECHARGEABLE PAR USB-C

 RECHARGEABLE VIA USB-C



Paille réutilisable en acier inoxydable avec étui de transport - système autonettoyant UV-C - Contribue à réduire l'utilisation de pailles jetables et à éviter les déchets plastiques - Solution de désinfection par UV-C validée par un laboratoire tiers avec une efficacité prouvée contre la plupart des bactéries et virus - Batterie rechargeable - 1x Brosse nettoyante (inclus) - Alimentation : sur port USB-C (câble inclus) - Matériaux : Aluminium - Acier inoxydable - ABS. Marquage conseillé: laser - tampographie.

Reusable stainless steel straw with UV-C auto sanitizing carrying case - Helps reduce use of disposable straws and prevent plastic waste - UV-C sanitizing solution validated by third party laboratory with proven efficiency against most common bacteria and viruses - Rechargeable battery - 1x cleaning brush (included) - Power supply: on a USB Type-C port (cable included) - Material: Aluminum - Stainless steel - ABS. Suggested branding: laser - pad print.

Ø2.4 x 12.5 cm / P. Brut 100 g
 Ø0.9 x 4.9" / G.W: 0.22 lbs

Colisage: 40p / Env. 4.8 kg
 Carton: 40p / Approx. 11 lbs

Couverts réutilisables en acier inoxydable (fourchette, couteau et cuillère) - Doté d'une LED UV-C unique pour désinfecter vos couverts et les protéger des bactéries et des virus - Batterie rechargeable intégrée - Alimentation: sur port USB-C (câble inclus) - Matériaux : Aluminium - Acier inoxydable - ABS. Marquage conseillé : laser - tampographie.

Reusable stainless-steel cutleries (fork, knife and spoon) - Boasting unique ultraviolet sanitizing LED to keep your essentials away from bacteria and viruses - Built-in rechargeable battery - Power supply: on a USB Type-C port (cable included) - Material: Aluminum - Stainless steel - ABS. Suggested branding: laser - pad print.

Étui: 19 x 4.2 x 2.8 cm - Couverts : 14 cm / P. Brut: 81 g
 Case: 7.5 x 1.6 x 0.8" - Cutleries: 5.5" / G.W: 0.18 lbs

LL157

NEW

NOMADAY PILLBOX

Travel pillbox with 7 compartments / *Pilulier de voyage avec 7 compartiments*
Design by Guillaume Delvigne



LH83

NEW

NOMADAY UV DRINK

Self-cleaning thermos bottle with UV-C sanitizer (17 fl. oz)
Bouteille thermos auto-nettoyante avec stérilisateur UV-C (500 ml)



Award



reddot winner 2023



PILULIER



PILL BOX

ADAPTÉE POUR
LE VOYAGESUITABLE
FOR TRAVEL7
COMPARTIMENTS7
COMPARTMENTS

SANS BPA



BPA FREE

FINITION
ALUMINIUMALUMINIUM
FINISHINGGOURDE
RÉUTILISABLEREUSABLE
BOTTLELED UV
ANTI-BACTÉRIENNEANTI-BACTERIAL
UV LEDÉLIMINE 99,9%
DES BACTÉRIESKILLS 99.9%
OF BACTERIASDÉSINFECTION AUTOMATIQUE
ET COMPLÈTE EN 1 MINAUTOMATIC & FULL
SANITIZING IN 1 MINRECHARGEABLE
PAR USB-CRECHARGEABLE
VIA USB-C

DG1

DR

N

DB

D

X

Pilulier semainier pour votre traitement ou garder vos médicaments toujours avec vous où que vous alliez - 7 compartiments pour votre prescription hebdomadaire ou simplement pour ranger certains de vos médicaments de base lors de vos voyages - Facile à nettoyer - Grands compartiments et finition de qualité supérieure. Matériaux : Aluminium - ABS. Marquage conseillé: sérigraphie - laser.

Stylish pill box to keep your treatment or essential medicines always with you wherever you go - 7 distinguished compartments for your weekly prescription or simply to store some of your basic medicines while traveling - Easy to clean inner material - Large compartments and premium finishing. Material: Aluminum - ABS. Suggested branding: silkscreen / laser.

17 x 3 x 1.6 cm / P.Brut: 140 g
6.7 x 1.2 x 0.4" / G.W: 0.31 lbs

Colisage: 40p / 3.7 kg
Carton: 40p / 8.16 lbs



DG1

DR

N

DB

D

X

Bouteille d'eau en aluminium de qualité alimentaire et de taille compacte - Capacité de 500 ml - Aide à réduire l'utilisation de bouteilles en plastique jetables - Sans BPA - Stérilisation par UV-C - Batterie rechargeable, jusqu'à 10 cycles sur une seule charge - Large choix de couleurs. Matériaux : Aluminium de qualité alimentaire - ABS. Marquage conseillé: laser - tampographie.

Compact size food grade aluminum water bottle - 500ml / 17oz capacity - Helps reducing use of disposable plastic bottles - BPA free - UV-C sanitizing - Rechargeable battery, up to 10 cycles on a single charge - large selection of colors. Material: Food grade aluminum - ABS. Suggested branding: laser - pad print.

10 x 4.6 x 21 cm I P. Brut : 280 g
3.94 x 1.57 x 8.27" I G.W: 0.62 lbs

Colisage : 20 p/6.2 kg
Carton: 20 p/13.67 lbs

MANO

Automatic hydroalcoholic gel dispenser with LED light
 Distributeur automatique de gel hydroalcoolique avec lumière LED

MANO

Design by Manuela Simonelli & Andrea Quaglio



AWARDS



- | | | | | | | |
|---|--|------------------|-----------------------|--------------------------------|------------------------------------|-------------------------------|
| DISTRIBUTEUR DE GEL SANS CONTACT | DÉTECTION AUTOMATIQUE DES MAINS | LAMPE LED | CAPACITÉ 160ML | DÉBIT DE POMPE RÉGLABLE | JUSQU'À 12 MOIS D'AUTONOMIE | RECHARGEABLE PAR USB-C |
| | | | | | | |
| CONTACTLESS GEL DISPENSER | AUTOMATIC HAND DETECTION | LED LIGHT | 5.4 oz CAPACITY | ADJUSTABLE PUMP FLOW | UP TO 12 MONTHS BATTERY LIFE | RECHARGEABLE VIA USB-C |

Distributeur automatique de gel hydroalcoolique avec lumière LED - Détection automatique des mains - Anneau LED éclairé avec intensité réglable - Réservoir de gel rechargeable - Capacité de 160 ml - Valve anti-goutte - Contrôles tactiles : Éclairage d'ambiance LED (lumière blanche froide ou chaude) / Réglage de la luminosité (faible à élevée) / Débit de pompe réglable - Indicateur LED (statut de charge) - Alimentation: rechargeable sur port USB-C (câble inclus) - Autonomie : jusqu'à 12 mois avec une utilisation quotidienne - Matériaux : ABS.

Automatic hydroalcoholic gel dispenser with LED light - Automatic hand detection - Embedded LED ring with adjustable brightness - Refillable gel tank capacity: 160ml / 5.4 oz - No-drip valve - Touch controls: Ambient LED lighting (cold or warm white light) / Adjustable brightness (low to high) / Adjustable pump flow - LED indicator (charging status) - Power supply: rechargeable on USB-C port (cable included) - Battery life : up to 12 months in daily use - Material: ABS.

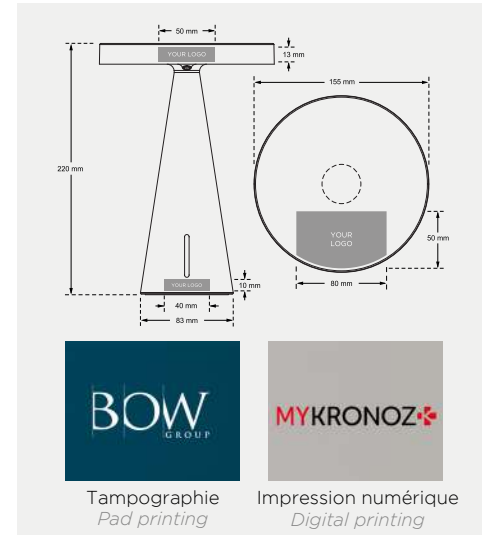

Ø 22 x 15.5 x Ø 8.2 cm / P. Brut: 870 g
 Ø 8.66 x 6.10 x Ø 3.23" / G.W: 1.92 lbs

Colisage: 6p / Env. 6.4 kg
 Carton: 6p / Approx. 14.11lbs

DIVA

Aromatherapy humidifier and mist maker with LED light
Humidificateur et brumisateur aromatherapique avec lumière LED

DIVA

Design by Manuela Simonelli & Andrea Quaglio



AWARDS



reddot winner 2023



DESIGN AWARD 2023



DIFFUSION SILENCIEUSE
AVEC TECHNOLOGIE
ULTRASONIQUE



SILENT DIFFUSION
WITH ULTRASONIC
TECHNOLOGY

BRUME FRAÎCHE
INOFFENSIVE



COOL MIST SAFE
FOR USE

LAMPE AVEC 9
COULEURS DE LED



LAMP WITH 9 LED
COLORS

VARIATEUR
D'INTENSITÉ



DIMMER

ARRÊT AUTOMATIQUE EN
CAS DE MANQUE D'EAU



AUTOMATIC SHUT-OFF
WHEN WATER TANK
IS EMPTY

RECHARGEABLE
PAR USB-C



RECHARGEABLE
VIA USB-C



N



W



D



TC



DG3



Diffuseur d'ambiance pour brume froide et huiles essentielles avec éclairage LED d'ambiance - Design contemporain avec finition en aluminium de qualité supérieure - Réservoir d'eau intégré - Commandes tactiles pour interagir avec la lampe LED - Luminosité et sélection des couleurs réglables - Alimentation: sur port USB-C (câble inclus). Matériaux : Aluminium - ABS.

Home diffuser for cold mist and essential oils with ambient LED lighting - contemporary design with premium aluminium finishing - built-in water tank - Touch controls to interact with LED lamp - Adjustable brightness and color selection - Power supply: on a USB Type-C port (cable included). Material: Aluminum - ABS.



Ø8.4 x Ø13.5 x 27 cm / P.Brut: 870 g
Ø 8.66 x 6.10 x Ø 3.23" | G.W: 1.92 lbs



Colisage: 6p / Env. 6.4 kg
Carton: 6p / Approx. 14.11lbs

ROMINO

Compact waterless aromatherapy diffuser / Diffuseur aromathérapique compact sans eau

ROMINO

Design by Manuela Simonelli & Andrea Quaglio



AWARD



reddot winner 2023



DIFFUSEUR COMPACT ET SILENCIEUX



COMPACT & SILENT DIFFUSER

FONCTIONNE SANS EAU



WORKS WITHOUT WATER

ARRÊT AUTOMATIQUE TOUTES LES 2 HEURES



AUTOMATIC SHUT-OFF EVERY 2 HOURS

JUSQU'A 8 HEURES D'AUTONOMIE



UP TO 8 HOURS BATTERY LIFE

RECHARGEABLE PAR USB-C



RECHARGEABLE VIA USB-C



Élégant diffuseur d'arômes compact sans eau - Quelques gouttes d'huiles essentielles pour procurer du bien-être et un air agréable à respirer - Autonomie: 8h - Temps de charge: 4h - Rechargeable sur port USB Type-C (câble inclus). Matériaux : Aluminium - ABS.

Elegant compact aroma diffuser without water - Few essential oils drops to provide wellness and good breathing air - Battery life: 8h - Charging time: 4h - Rechargeable on USB Type-C port (cable included). Material: Aluminum - ABS.

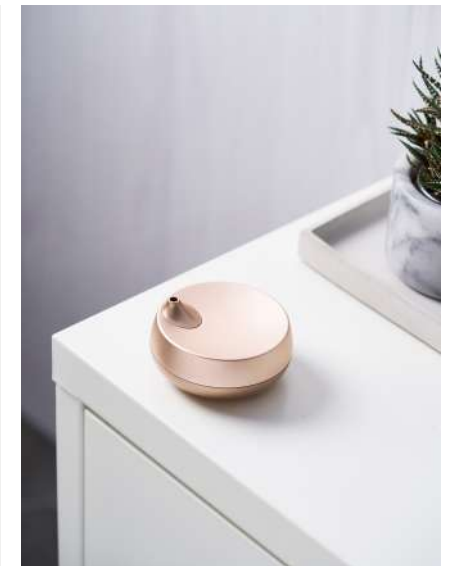
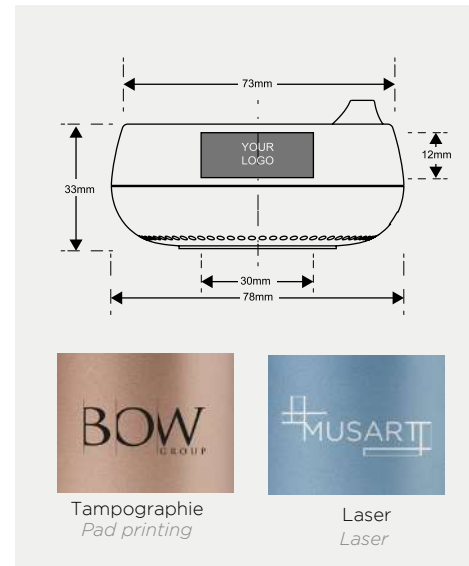

Ø7.8 x 3.3 cm / P.Brut: 130 g
2.87 x 1.29" | G.W: 0.29 lbs

Colisage: 40p / Env. 6 kg
Carton: 40p / Approx. 13.22 lbs

LH104

NEW

ARIA

Air purifier / Purificateur d'air
Design by Manuela Simonelli & Andrea Quaglio



PURIFICATEUR
D'AIR



AIR
PURIFIER

FILTRE
HEPA



HEPA
FILTER

ÉCRAN DE
CONTRÔLE TACTILE



TOUCH CONTROL
PANEL

3 VITESSES
AJUSTABLES



3 ADJUSTABLE
SPEEDS

MODE
SILENCIEUX



SILENT
MODE

ALIMENTATION
VIA USB-C



POWER SUPPLY
VIA USB-C



BG



W



LG

Purificateur d'air - Filtre HEPA - Convient à une pièce jusqu'à 20 m² - 3 vitesses - Panneau de commandes tactiles - Mode de fonctionnement silencieux - Connecteur USB-C pour l'alimentation. Matériaux : ABS. Marquage conseillé : laser - tampographie.

Air purifier - HEPA filter - Suitable for room up to 20 sqm (215 sqft) - 3 speeds - Touch controls panel - Quiet operating mode - USB-C connector for power. Material: ABS. Suggested branding: laser - pad print.

Ø21 x 38 cm / P.Brut: TBC
Ø8.27 x 14.96" / G.W: TBC

LH103

NEW

BIRDY

Air quality monitor / Capteur de qualité d'air
Design by Manuela Simonelli & Andrea Quaglio



CAPTEUR
CO₂



CO₂
SENSOR

INDICATEUR LUMINEUX
POUR LA QUALITÉ DE L'AIR



LIGHT INDICATOR
FOR AIR QUALITY

SUIVI DE LA TEMPÉRATURE
INTÉRIEURE ET DE
L'HUMIDITÉ



INDOOR TEMPERATURE &
HUMIDITY MONITORING

ÉCRAN
LED



LED
DISPLAY

ALIMENTATION
VIA USB-C



POWER SUPPLY
VIA USB-C



D



LB1



X



LG

Capteur de qualité d'air - Une tête lumineuse conçue pour donner une indication visuelle de la qualité de l'air intérieur - Trois couleurs de lumière pour indiquer différents niveaux de qualité de l'air - Commande tactile pour allumer l'écran pendant quelques secondes et obtenir des données sur la qualité de l'air, la température et l'humidité relative - Rechargeable sur port USB-C (câble inclus). Matériaux : Aluminium - ABS. Marquage conseillé : laser - tampographie.

Air quality monitor - A light head designed to give a visual indication of indoor air quality - Three light colors to indicate different levels of air quality - Touch control to turn on the display for a few seconds and get data on air quality, temperature and relative humidity - Rechargeable on USB-C port (cable included). Material: Aluminum - ABS. Suggested branding: laser - pad print.

10.6 x 11.9 cm / P. Brut: 220 g
4.17 x 4.68" / G.W: 0.48 lbs

Colisage: 20 pcs / 4.4 kg
20 pcs / 9.7 lbs

OBLIO

Wireless charging station with built-in UV-C sanitizer
Station de charge à induction avec stérilisateur UV-C intégré

OBLIO

Design by Manuela Simonelli & Andrea Quaglio



AWARDS



LED UV-C ANTIBACTÉRIENNE



ANTIBACTERIAL UV-C LED

ÉLIMINE 99.9% DES BACTÉRIES



KILLS UP TO 99.9% OF BACTERIA

DÉSINFECTION AUTOMATIQUE ET COMPLÈTE DE L'ÉCRAN EN 20 MIN



AUTOMATIC & FULL SCREEN SANITIZING IN 20 MIN

STATION DE CHARGE À INDUCTION



WIRELESS CHARGER

CHARGE RAPIDE 10W



10W FAST CHARGING

COMPATIBLE AVEC LES SMARTPHONES DOTÉS DE LA TECHNOLOGIE Qi



COMPATIBLE WITH Qi ENABLED SMARTPHONES



N



DB



D



Station de charge à induction 10W avec stérilisateur UV intégré - Certifié Qi - Charge rapide : environ 3h pour une charge complète du smartphone - Lampe UV-C antibactérienne - Élimine 99,9% des germes et bactéries sur l'écran de votre smartphone en 20 minutes - Retournez votre smartphone pour une désinfection complète à 360° - Testé en laboratoire contre les bactéries communes - Efficacité scientifiquement prouvée contre les virus dont le H1N1 - Cycle de désinfection automatique - Indicateur LED pour positionnement correct et statut de charge - Compatible avec les smartphones dotés de la technologie de charge Qi avec des dimensions allant jusqu'à 8,3 cm de largeur / 1,05 cm d'épaisseur, coque incluse (non métallique) - Détection d'objets étrangers - Alimentation : sur port USB-C (câble inclus) et sur adaptateur secteur certifié Quick Charge 3.0 ou un adaptateur secteur USB DC 9V/2A (non inclus) - Matériaux : ABS - Finition gomme.

10W Wireless charging station with built-in UV sanitizer - Qi-certified - Fast charging: approximately 3h required for a full smartphone charge - Antibacterial UV-C light - Eliminates 99.9% of germs and bacteria on your smartphone screen in 20 minutes - Flip your smartphone for a complete 360° disinfection - Laboratory tested against common bacteria - Scientifically proven to be effective against viruses including H1N1 - Automatic sanitizing cycle - LED indicator for proper placement and charging status - Compatible with Qi-enabled smartphones with size up to 8.3 cm wide / 1.05 cm thick including case (not metal) - Foreign object detection - Power supply: on USB-C port (cable included) and a Quick Charge 3.0 certified power adapter or a USB DC 9V/2A power adapter (not included) - Material: ABS - Rubber finishing.

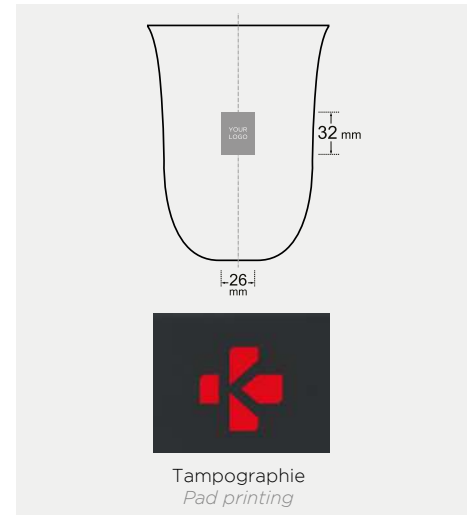

Tamppographie
Pad printing

Ø 13.6 x 17.5 cm | P. Brut : 775 g
Ø 5.36 x 6.89" | GW : 1.71 lbs



Colisage : 12 p/10.220 kg
Carton : 12p/ 22.5 lbs

OBLIO BOX

Wireless charging station with built-in UV-C sanitizer
Station de charge à induction avec stérilisateur UV-C intégré



LED UV-C
ANTIBACTÉRIENNE



ANTIBACTERIAL
UV-C LED

ÉLIMINE 99.9%
DES BACTÉRIES



KILLS UP TO 99.9%
OF BACTERIA

DÉSINFECTION AUTOMATIQUE
ET COMPLÈTE EN 5 MIN



AUTOMATIC & FULL
SANITIZING IN 5 MIN

STATION DE CHARGE
À INDUCTION



WIRELESS
CHARGER

CHARGE
RAPIDE 10W



10W FAST
CHARGING

COMPATIBLE AVEC LES
APPAREILS DOTÉS DE LA
TECHNOLOGIE Qi



COMPATIBLE WITH Qi
ENABLED DEVICES



W



N

OBLIO BOX

Design by Manuela Simonelli & Andrea Quaglio



Boîtier de stérilisation UV-C avec chargeur à induction 10W - Certifié Qi - Charge rapide : environ 3h pour une charge complète du smartphone - Lampe UV-C antibactérienne - Élimine 99,9% des germes et bactéries sur votre smartphone en 5 minutes - Désinfectant UV : tout produit pouvant entrer dans le boîtier de stérilisation, comme les lunettes, montre, bijoux, écouteurs, masques, smartphones - Stérilisation UV à 360° - Testé en laboratoire contre les bactéries communes - Efficacité scientifiquement prouvée contre les virus dont le H1N1 - Cycle de désinfection automatique - Indicateur LED pour positionnement correct et statut de charge - Compatible avec la plupart des téléphones et appareils prenant en charge la charge à induction et compatibles Qi - Alimentation : sur port USB-C (câble inclus) et sur adaptateur secteur certifié Quick Charge 3.0 ou un adaptateur secteur USB DC 9V/2A (non inclus) - Matériaux : ABS.

UV-C sanitizer with built-in 10W wireless charger - Qi-certified - Fast charging: approximately 3h required for a full smartphone charge - Advanced anti-bacterial UV-C light - Eliminates 99,9% of your smartphone germs and bacteria in 5 minutes - UV sanitizer: any goods that can fit into the sanitizer, such as glasses, watch, jewelry, earphones, masks, smartphones - 360°UV sterilization - Cycle Laboratory tested against common bacteria - Scientifically proven to be effective against viruses including H1N1 - Unique and secured rotating closing cap - Automatic sanitizing cycle - LED indicator for proper placement and charging status - Compatible with most phones and devices that support wireless charging and are Qi-compatible - Foreign object detection - Power supply: on USB-C port (cable included) and a Quick Charge 3.0 certified power adapter or a USB DC 9V/2A power adapter (not included) - Material: ABS.

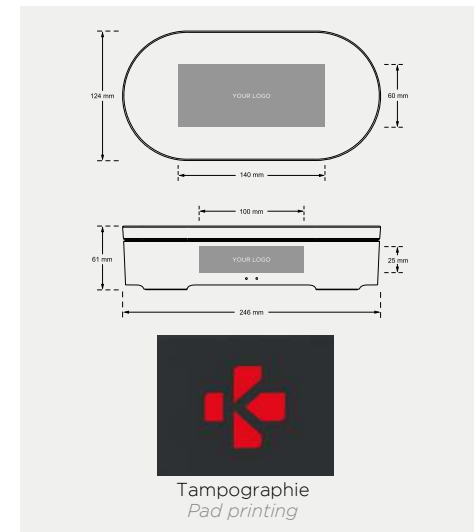

24.6 x 12.4 x 6.1 cm | P.Brut : 880 g
9.68 x 4.88 x 2.40" | G.W: 1.94 lbs



Colisage: 12p/11 kg
Carton: 12p/24.25 lbs



- LED UV-C ANTIBACTÉRIENNE**
ANTIBACTERIAL UV-C LED
- ÉLIMINE 99.9% DES BACTÉRIES**
KILLS UP TO 99.9% OF BACTERIA
- DÉSINFECTION AUTOMATIQUE ET COMPLÈTE EN 5 MIN**
AUTOMATIC & FULL SANITIZING IN 5 MIN
- CHARGE RAPIDE 2X15W**
2X 15W FAST CHARGING
- 2 EMPLACEMENTS POUR SMARTPHONES**
2 SMARTPHONES SLOTS
- COMPATIBLE AVEC LES SMARTPHONES DOTÉS DE LA TECHNOLOGIE Qi**
COMPATIBLE WITH Qi ENABLED SMARTPHONES



- BATTERIE EXTERNE 5000 mAh**
5000 mAh POWER BANK
- LED UV-C ANTIBACTÉRIENNE**
ANTIBACTERIAL UV-C LED
- ÉLIMINE 99.9% DES BACTÉRIES**
KILLS UP TO 99.9% OF BACTERIA
- CÂBLE USB-C ET LIGHTNING INTÉGRÉ**
BUILT-IN USB-C & LIGHTNING CABLE



Double station de charge à induction 2x15W avec stérilisateur UV intégré - Certifié Qi - Charge rapide : environ 2h pour une charge complète du smartphone - Lampe UV-C antibactérienne (LED & CCFL) - Élimine 99,9% des germes et bactéries sur votre smartphone en quelques minutes - Testé en laboratoire contre les bactéries communes - Efficacité scientifiquement prouvée contre les virus dont le H1N1 - Couvercle de fermeture rotatif unique et sécurisé - Cycle de désinfection automatique - Indicateur LED pour positionnement correct et statut de charge - Compatible avec les smartphones dotés de la technologie de recharge sans fil Qi avec des dimensions allant jusqu'à 16,8cm de hauteur / 8,5 cm de largeur / 1,5 cm d'épaisseur, coque incluse (non métallique) - Détection d'objets étrangers - Alimentation : sur port USB-C (câble inclus) et sur adaptateur secteur certifié Quick Charge 45W (non inclus) - Matériaux : ABS. Marquage conseillé : Sérigraphie.

2x 15W dual wireless charging station with built-in UV sanitizer - Qi-certified - Fast charging: approximately 2h required for a full smartphone charge - Advanced anti-bacterial UV-C light combination (LED & CCFL) - Eliminates 99,9% of your smartphone germs and bacteria in a few minutes - Cycle Laboratory tested against common bacteria - Scientifically proven to be effective against viruses including H1N1 - Unique and secured rotating closing cap - Automatic sanitizing cycle - LED indicator for proper placement and charging status - Compatible with Qi-enabled smartphones with size up to 168 mm length / 85 mm wide / 15 mm thick including case (not metal) - Foreign object detection - Power supply: on USB-C port (cable included) and a Quick Charge 45W (not included) - Material: ABS. Suggested branding: Silkscreen.

Ø 14,8x19,9 cm | P. Brut : 980 g
 Ø 5.8x7.835" | G.W. : 2.16 lbs

Colisage : 12 p/ 13 kg
 Carton : 12p/ 28.6 lbs

Colors on request / Couleurs sur demande

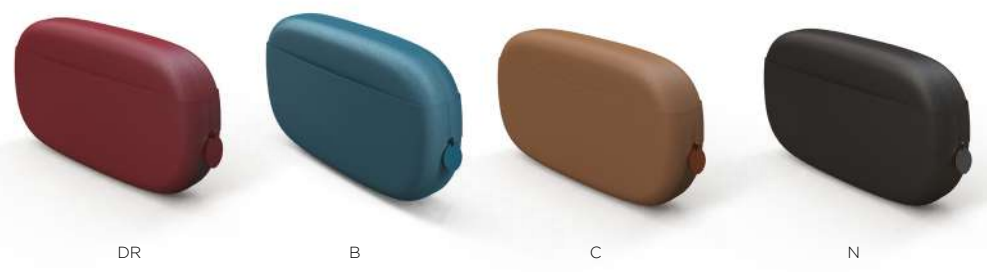

Pochette avec stérilisateur uv intégré et câbles de charge - Batterie externe de 5000 mAh - Câble intégré avec connecteurs Universal Lightning et USB-C - Lampe UV-C antibactérienne - Élimine 99,9% des germes de votre smartphone en 10 minutes - Testé en laboratoire contre les bactéries communes - Efficacité scientifiquement prouvée contre les virus dont le H1N1 - Fermeture magnétique sécurisée - Cycle de désinfection automatique - Indicateur LED pour les cycles de charge et de désinfection - Compatible avec les smartphones d'une taille allant jusqu'à 17cm de hauteur, 8,5 cm de largeur, 2,8 cm d'épaisseur, coque incluse (non métallique) - Alimentation: sur port USB-C (câble intégré) et adaptateur secteur USB DC 9V/2A (non inclus). Matériaux : EVA / enveloppé en cuir PU. Marquage conseillé : Sérigraphie.

Pouch with built-in uv sanitizer and charging cables - 5000 mAh battery - Built-in cable with Universal lightning and USB-C connectors - Advanced anti-bacterial UV light - Eliminate 99,9% of your smartphone germs in 10 minutes - Laboratory tested against common bacteria - Scientifically proven to be effective against viruses including H1N1 - Secured magnetic closing - Automatic sanitizing cycle - LED indicator for charging and sanitizing cycles - Compatible with smartphones with size up to 170 mm length / 85 mm wide / 28 mm thick including case (not metal) - Power supply: on USB-C port (built-in cable) and USB DC 9V/2A power adapter (not included). Material: EVA / PU-leather wrapping. Suggested branding: Silkscreen.

20,8x11,3x4,5 cm | P. Brut : 500 g
 8.1x4.4x1.7" | G.W. : 1.32 lbs

Colisage : 12 p/ 7,8 kg
 Carton : 12p/ 17.2 lbs

ZEN COLLECTION

Design by LEXON Studio

ZEN COLLECTION

Design by LEXON Studio

LEXON[®]
STUDIO

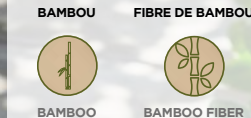

LH39 - ZEN CUP

LH40 - ZEN LARGE CUP

LH42 - ZEN COTTON BOX

LH43 - ZEN TISSUE BOX



W8

Pot pour brosses à dents - 4 compartiments
Matériaux : bambou - fibre de bambou.
Marquage conseillé : sérigraphie

8,7 x 3,2 x 13,8 cm | P. Brut: 250 g / Colisage :
40 p/10,840 kg / s/c: 10 p

*Toothbrush cup - 4 compartments - Material:
bamboo / bamboo fiber. Suggested
branding: silkscreen.*

3,4 x 1,3 x 5,4" | G.W: 0,55 lbs / Carton: 40 p/
23,9 lbs / i/c: 10 p



W8

Rangement pour salle de bain -
4 compartiments - Matériaux : bambou - fibre
de bambou. Marquage conseillé : sérigraphie.

21 x 8,8 x 8 cm | P.Brut: 375g / Colisage:
40p/17,560kg / s/c: 10p

*Bathroom organizer - 4 compartments -
Material: bamboo / bamboo fiber. Suggested
branding: silkscreen.*

8,3 x 3,5 x 3,1" | G.W: 0,8 lbs / Carton: 40 p/
38,7 lb/ i/c: 10 p



W8

Boîtes de rangement pour salle de bain -
Pour coton, cotons-tiges, maquillage...
Matériaux : bambou - fibre de bambou.
Marquage conseillé : sérigraphie.

15,4 x 8,4 x 9,4 cm | P. Brut: 430 g / Colisage :
40 p/19,040 kg/ s/c : 10 p

*Bathroom organizer boxes - For cotton,
cottons buds, make up... Material: bamboo /
bamboo fiber. Suggested branding: silkscreen.*

6 x 3,3 x 3,7" | G.W: 0,95 lbs / Carton: 40 p/
42 lbs / i/c: 10 p



W8

Boîte décorative pour mouchoirs en papier
- Matériaux : bambou - fibre de bambou.
Marquage conseillé : sérigraphie.

26,5 x 13,7 x 8 cm | P. Brut: 390 g / Colisage :
40 p/23,8 kg / s/c : 10 p











*Decorative tissue box - Material: bamboo
/ bamboo fiber. Suggested branding:
silkscreen.*

10,4 x 5,4 x 3" | G.W: 1,1 lbs / Carton: 40 p/
54,7 lbs / i/c: 10 p

CHARGE
CHARGER



CHARGE CHARGER

-  **SOFTPOWER**
MAGBANK NEW
-  **SOFTPOWER**
WIRELESSBANK
-  **POWERSOUND**
-  **OSLO ENERGY+**
-  **POWERON** NEW
-  **UNO & DUO MINI CHARGER**
-  **FINE TUBE POWER BANK 2**
-  **NOMADAY POWER BANK**
- NEW **TELA** 
-  **METALI-C** NEW
- NEW **PEAS POWER** 

SOFTPOWER MAGBANK

Compact magnetic wireless power bank Magsafe compatible
 Batterie sans fil compacte & magnétique compatible Magsafe



- BATTERIE EXTERNE 3000 mAh**

 3000 mAh POWER BANK
- COMPATIBLE MAGSAFE (iPhone 12 et plus récent)**

 MAGSAFE COMPATIBLE (iPhone 12 and newer)
- CHARGEUR À INDUCTION CERTIFIÉ Qi**

 Qi-CERTIFIED WIRELESS CHARGER
- FONCTIONNE AVEC TOUS LES APPAREILS DOTÉS DE LA TECHNOLOGIE Qi**

 WORKS WITH ALL Qi ENABLED DEVICES
- FINITION RÉSISTANTE CUIR SYNTHÉTIQUE**

 DURABLE SYNTHETIC LEATHER FINISHING
- PORT USB-C POUR CHARGER ET RECHARGER**

 TWO-WAY USB PORT TO CHARGE



SOFTPOWER MAGBANK

Design by Alain Berteau



Batterie externe premium de 3000 mAh compatibles Magsafe (iPhone 12 et plus récent) avec connecteur Type-C à double sens - 5W en sortie de charge sans fil Qi et 15W via câble - Compatible avec tous les appareils Qi - Peut charger 2 appareils simultanément - Design compact et finition en cuir synthétique de qualité supérieure - Délivre une charge complète, varie selon le smartphone - Temps de charge : 2h - Alimentation: sur port USB-C (câble inclus) - Matériaux : Cuir synthétique - ABS.

Premium Magsafe compatible (iPhone 12 and newer) 3000 mAh powerbank with dual way Type-C connector - 5W Qi wireless charging output and up to 15W via cable - Compatible with any Qi devices - Can charge 2 devices simultaneously - Compact design and premium synthetic leather finishing - Delivers one full charge depending on smartphone - Charging time: 2h - Power supply: on USB-C port (cable included) - Material: Synthetic leather - ABS.

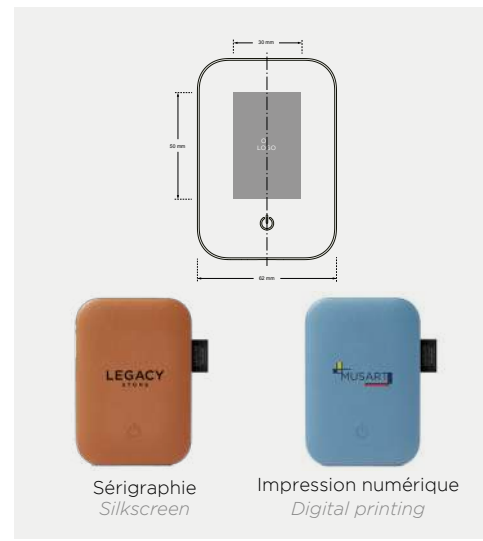

5.5 x 2 x 8.5 cm / P. Brut: 178 g
 2.1 x 0.7 x 3.3" / G.W: 0.39 lbs



Colisage: 40p / Env. 7.6 kg
 Carton: 40p / Approx. 16.75 lbs

SOFTPOWER WIRELESSBANK

10 000 mAh power bank with built-in wireless charger
 Batterie externe 10 000 mAh avec chargeur à induction intégré

SOFTPOWER WIRELESSBANK

Design by Alain Berteau



- BATTERIE EXTERNE
10000 mAh**



10 000 mAh
POWER BANK
- CHARGEUR À
INDUCTION CERTIFIÉ Qi**



Qi-CERTIFIED
WIRELESS CHARGER
- CHARGE RAPIDE
15W**



15W
FAST CHARGING
- FONCTIONNE AVEC TOUS
LES APPAREILS DOTÉS
DE LA TECHNOLOGIE Qi**



WORKS WITH
ALL Qi ENABLED
DEVICES
- FINITION RÉSIDANTE
CUIR SYNTHÉTIQUE**



DURABLE SYNTHETIC
LEATHER FINISHING
- PORT USB-C POUR
CHARGER ET
RECHARGER**



TWO-WAY USB
PORT TO CHARGE
& RECHARGE

Batterie externe 10 000 mAh avec chargeur à induction certifié Qi - Charge rapide 15W : environ 3h pour une charge complète du smartphone - Compatible avec tous les appareils Qi - Port USB-C bidirectionnel pour charger et se recharger (câble inclus). Matériaux : ABS - PC enveloppé de cuir synthétique.

10 000 mAh power bank with Qi certified wireless charger - 15W fast charging: approx 3h for a full smartphone charge - Compatible with all Qi enabled devices - Dual way USB-C connector for charging and recharging (cable included). Material: ABS - PC wrapped with synthetic leather.

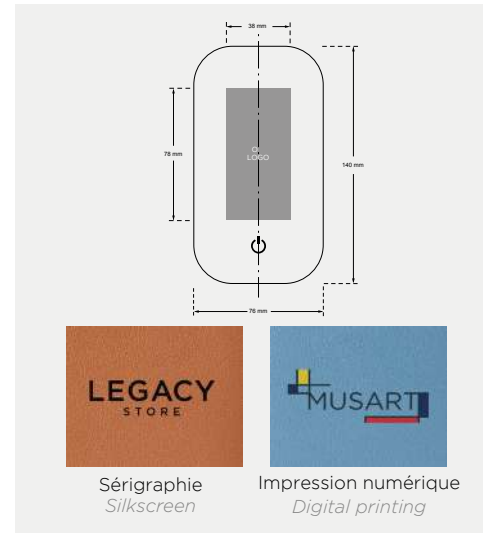

14 x 7,6 x 1,74 cm / P. Brut: 292 g
 5,5 x 2,99 x 0,69" / G.W: 0,64 lbs

Colisage: 20p / Env. 7.6 kg
 Carton: 20p / Approx. 16.75 lbs

POWERSOUND

5 000 mAh wireless power bank with Bluetooth® speaker
 Batterie externe 5 000 mAh avec chargeur à induction & enceinte Bluetooth® intégrée

POWERSOUND

Design by Alain Berteau



AWARDS



- CHARGEUR À INDUCTION Qi 5000 mAh**
5 000 mAh Qi WIRELESS CHARGER
- FONCTIONNE AVEC TOUS LES APPAREILS DOTÉS DE LA TECHNOLOGIE Qi**
WORKS WITH ALL Qi ENABLED DEVICES
- ENCEINTE BLUETOOTH® 5W**
5W BLUETOOTH® SPEAKER
- JUSQU'À 20H D'AUTONOMIE**
UP TO 20 HOURS PLAYTIME
- RECHARGE ET CHARGE SANS FIL**
SOLELY WIRELESS CHARGING AND RECHARGING
- FINITION RÉSISTANTE CUIR SYNTHÉTIQUE**
DURABLE SYNTHETIC LEATHER FINISHING



Batterie externe 5 000 mAh et chargeur à induction Qi avec enceinte Bluetooth® intégrée - Chargeur à induction 5W - Compatible avec tous les appareils dotés de la technologie de charge Qi - Enceinte Bluetooth® 3W - Autonomie : jusqu'à 20h - Se recharge et charge par induction, entièrement sans fil - Matériaux : ABS enveloppé de cuir synthétique.

5 000 mAh Qi wireless power bank with Bluetooth® speaker - 5W wireless charger - Compatible with all Qi enabled devices - 3W Bluetooth® speaker - Playtime: up to 20h - Solely wireless charging and recharging - Material: ABS wrapped with synthetic leather.

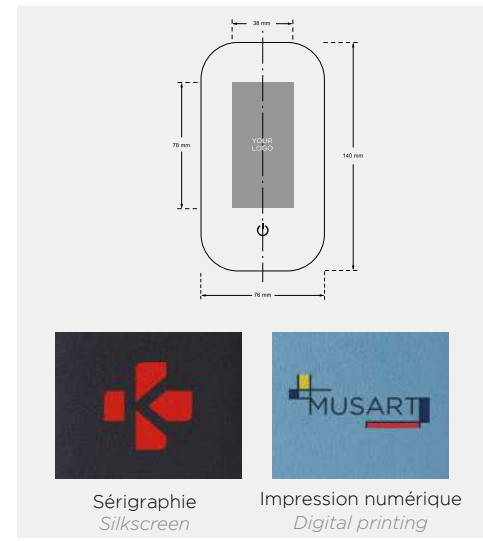

7,6 x 2,3 x 14 cm / P. Brut: 260 g
 2.99 x 0.78 x 5.51" / G.W: 0.42 lbs

Colisage: 20p / Env. 6.2 kg
 Carton: 20p / Approx. 13.66 lbs

OSLO ENERGY+

Wireless charging station with Bluetooth® speaker & microphones
Station de charge à induction avec enceinte Bluetooth® & microphones

OSLO ENERGY+

Design by Manuela Simonelli & Andrea Quaglio



CHARGEUR A INDUCTION 10W



10W WIRELESS CHARGER

ENCEINTE BLUETOOTH®



BLUETOOTH® SPEAKER

DOUBLE MICROPHONE



DUAL MICROPHONE

OPTIMISÉ POUR LES CONFÉRENCES AUDIOS



OPTIMIZED FOR CONFERENCE CALLS

RÉDUCTION DU BRUIT AMBIANT



AMBIANT NOISE CANCELLING

FINITION RÉSISTANTE CUIR SYNTHÉTIQUE



DURABLE SYNTHETIC LEATHER FINISHING

Station de recharge sans fil avec haut-parleur Bluetooth® et microphones - Station de charge à induction 10W certifiée Qi - Enceinte Bluetooth® 5W - Compatible avec les appareils utilisant la technologie Qi - Appels mains-libres - Double microphones avec réduction du bruit ambiant - Indicateur de charge sans fil et LED Bluetooth® - Version Bluetooth® : 5.0 | Distance Bluetooth® : 10m - Alimentation : utilisation recommandée sur port USB-C (câble inclus) et sur adaptateur secteur certifié Quick Charge 3.0 ou un adaptateur secteur USB DC 9V/2A (non inclus). Matériaux : Cuir PU - ABS.

Wireless charging station with Bluetooth® speaker & microphones - 10W Qi wireless charging station - 5W Bluetooth® speaker - Compatible with Qi-enabled devices - Hands-free conference calls - Environment noise-cancelling microphones - Wireless charging & Bluetooth® - LED lights indicator - Bluetooth® version: 5.0 | Bluetooth® distance: 10m - Connection: USB Type-C (cable included) - Power supply: recommend to use with Quick Charge 3.0 power adapter (not included) or a DC 9V/2 power adapter (not included). Material: PU leather- ABS.



C



DB



N



DR

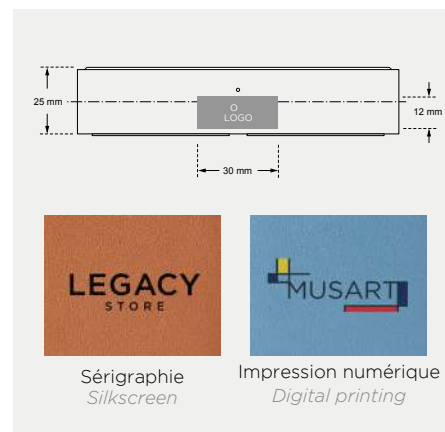

Ø 12x2,5 cm | P.Brut : 423 g
Ø 4.7x0.9" | G.W: 0.93 lbs



Colisage : 20p/9,04 kg
Carton: 20p/19,9 lbs

POWERON

Dual USB wall fast charger - PD 30W
Chargeur secteur rapide avec double port USB - PD 30W

POWERON

Design by LEXON Studio

AWARD



reddot winner 2023



PORT USB-C
+ PORT USB-A



USB-C PORT
+ USB-A PORT

TECHNOLOGIE DE CHARGE
RAPIDE POWER DELIVERY (PD)



POWER DELIVER FAST CHARGING
TECHNOLOGY (PD)

CHARGE 2 APPAREILS
SIMULTANÉMENT



CHARGE 2 DEVICES
SIMULTANEOUSLY

ADAPTATEURS US + EU
INCLUS US + EU



US + EU PLUGS
INCLUDED

FORMAT
COMPACT



COMPACT
DESIGN

FINITION RÉSISTANTE
CUIR SYNTHÉTIQUE



DURABLE SYNTHETIC
LEATHER FINISHING



Chargeur secteur rapide avec double port USB - 1 Port USB-C PD + 1 Port USB-A QC 3.0 - Technologie de charge rapide Power Delivery (PD) - Jusqu'à 30W de puissance - Capable de recharger jusqu'à 2 appareils simultanément - Prises US + EU incluses - Format compact - Finition premium en cuir synthétique. Matériaux: Cuir synthétique - ABS.

Dual USB wall fast charger - 1 USB-C PD port + 1 USB-A QC 3.0 port - Power Delivery fast charging technology (PD) - Up to 30W of power - Can charge up to 2 devices simultaneously - US + EU plugs included - Compact design - Premium synthetic leather finish. Materials: Synthetic leather - ABS.

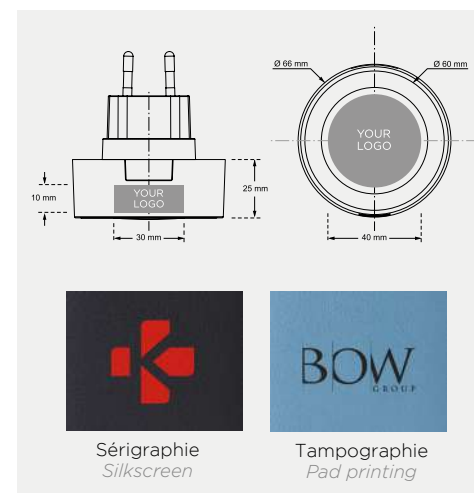

Ø 6.6 x 2.5 cm / P. Brut: 150 g
Ø 2.36 x 0.79" / G.W: 0.33 lbs

Colisage: 40p / Env. 6.9 kg
Carton: 40p / Approx. 15.21 lbs

LD146

UNO MINI CHARGER

10W Qi wireless charger / Chargeur à induction Qi 10W
Design by Manuela Simonelli & Andrea Quaglio



CHARGEUR
À INDUCTION Qi



Qi WIRELESS
CHARGER

CHARGE RAPIDE
10W



10W
FAST CHARGING

FONCTIONNE AVEC TOUS
LES APPAREILS DOTÉS
DE LA TECHNOLOGIE Qi



WORKS WITH
ALL Qi ENABLED
DEVICES

ULTRA
FIN



EXTRA
SLIM

CÂBLE USB
INTÉGRÉ



BUILT-IN
USB CABLE



Chargeur à induction 10W - Certifié Qi - Compatible avec Mino+ et Mina M/L Compatible avec les smartphones et écouteurs dotés de la technologie de charge sans fil Qi (environ 4h pour une charge complète) - Alimentation : sur port USB-C (câble inclus). Matériaux : ABS - Alliage de zinc - Silicone - Marquage conseillé : tampographie.

10W slim wireless charger - Qi-certified - Compatible with Mino+ and Mina M/L - Compatible with Qi-enabled smartphones & earbuds (approx 4 hours for a full charge) - Power supply on USB-C port (cable included). Material: ABS / Zinc alloy - Silicone - Suggested branding: pad print.

6,7 x 6,0 x 0,85 cm | P.Brut : 108g
2,64 x 2,36 x 0,33" | G.W: 0.24 lbs

Colisage : 40 p / 5.34 kg
Carton: 40 p / 11 lbs

LD147

DUO MINI CHARGER

12x5W Qi dual wireless charger / Chargeur double à induction Qi 2x5W
Design by Manuela Simonelli & Andrea Quaglio



CHARGEUR DOUBLE
À INDUCTION Qi



Qi DUAL WIRELESS
CHARGER ER

CHARGE
2 x 5W



2 X 5W
CHARGING

FONCTIONNE AVEC TOUS
LES APPAREILS DOTÉS
DE LA TECHNOLOGIE Qi



WORKS WITH
ALL Qi ENABLED
DEVICES

ULTRA
FIN



EXTRA
SLIM

CÂBLE USB
INTÉGRÉ



BUILT-IN
USB CABLE



Chargeur double à induction 2x5W - Certifié Qi - Compatible avec Mino+ et Mina M/L - Compatible avec les smartphones et écouteurs dotés de la technologie de charge sans fil Qi (environ 4h pour une charge complète) - Double zone de charge sans fil pour recharger 2 produits simultanément - Alimentation : sur port USB-C (câble inclus). Matériaux : ABS - Alliage de zinc - Silicone. Marquage conseillé: tampographie.

2x5W dual slim wireless charger - Qi-certified - Compatible with Mino+ and Mina M/L - Compatible with Qi-enabled smartphones & earbuds (approx 4 hours for a full charge) - Dual wireless charging coil to charge 2 Devices at once - Power supply on USB-C port (cable included).. Material: ABS - Zinc alloy - Silicone - Suggested branding: pad print.

14,0 x 6,8 x 0,85 cm | P.Brut : 214 g
5,51 x 2,67 x 0,33" | G.G.W: 0.36 lbs

Colisage : 20 p / 5.25 kg
Carton: 20 p / 11 lbs

LL130

FINE TUBE POWER BANK 2

3 000 mAh power bank / Batterie externe 3 000 mAh
Design by Pauline Deltour



BATTERIE EXTERNE
3000 mAh



3000 mAh
POWER BANK

PORT
USB



USB
PORT

PORT
USB-C



USB-C
PORT

FINITION
ALUMINIUM



ALUMINIUM
FINISHING

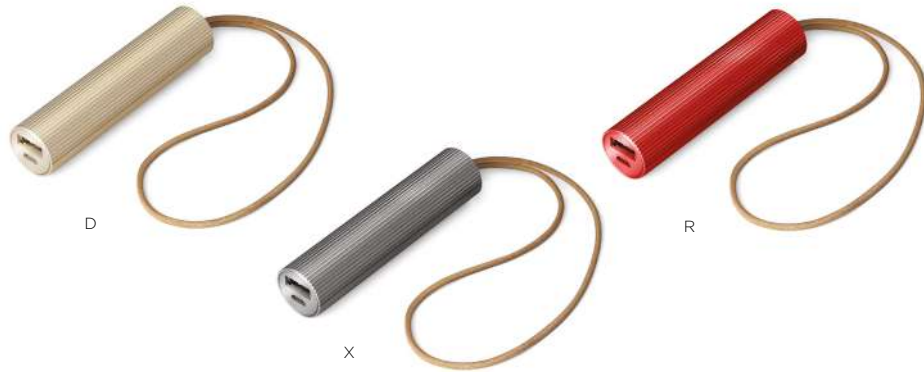

Batterie externe de 3 000 mAh - Port d'entrée USB-C / Port de sortie USB - Matériaux : Aluminium - Cuir. Marquage conseillé : laser - tampographie.

3 000 mAh Power Bank - USB-C input port / USB output port . Material: Aluminum - Leather. Suggested branding: laser - pad print.

Ø2 x 9,5 cm | P. Brut : 93 g
0,79 x 3,74" | G.W: 0.1 lbs

Colisage : 60 p/ 6,3 kg
Carton: 60 p/13.4 lbs

LL138

NOMADAY POWER BANK

3000 mAh power bank with clip / Batterie externe 3 000 mAh avec mousqueton
Design by Guillaume Delvigne



BATTERIE EXTERNE
3000 mAh



3000 mAh
POWER BANK

PORT
USB



USB
PORT

PORT
USB-C



USB-C
PORT

FINITION
ALUMINIUM



ALUMINIUM
FINISHING



Batterie externe de 3 000 mAh - Indicateur LED - Mousqueton intégré 2 ports : USB-A et USB-C - Matériaux : Mousqueton en alliage de zinc - Corps en aluminium. Marquage conseillé : sérigraphie-laser.

3 000 mAh Power Bank - LED indicator - Built-in hook handle 2 ports: USB-A and USB-C - Material: Zinc hook - Aluminum body. Suggested branding: silkscreen-laser.

Ø3,5 x 13,3 cm | P.Brut : 156 g
Ø1.38 x 5.24" | G.W: 0.34 lbs

Colisage : 50 p/9,25 kg
Carton: 50 p/20.4 lbs

TELA

3-in-1 magnetic wireless charging station with LED lamp
 Station de charge sans fil magnétique 3-en-1 avec LED intégrée



STATION DE CHARGE À INDUCTION



WIRELESS CHARGER

COMPATIBLE MAGSAFE (iPhone 12 et plus récent)



MAGSAFE COMPATIBLE (iPhone 12 and newer)

FONCTIONNE AVEC TOUS LES APPAREILS DOTÉS DE LA TECHNOLOGIE Qi



WORKS WITH ALL Qi ENABLED DEVICES

LAMPE AVEC 9 COULEURS DE LED



LAMP WITH 9 LED COLORS

VARIATEUR D'INTENSITÉ



DIMMER



D



AP



DG3



N

TELA

Design by Manuela Simonelli & Andrea Quaglio



Station de charge sans fil magnétique 3-en-1 avec LED intégrée - Pour iPhone + Apple Watch + AirPods - Connexion rapide et sécurisée en mode portrait ou paysage - Charge jusqu'à 15W pour iPhone 12 ou plus récent - Surface de recharge sur le dessus compatible avec la plupart des téléphones et appareils qui prennent en charge la recharge sans fil - Lumière blanche froide ou chaude + 7 couleurs - Variateur d'intensité - Contrôle tactile - Alimentation : sur port USB-C (câble inclus) et un adaptateur d'alimentation certifié Quick Charge 3.0 ou un adaptateur d'alimentation USB DC 9V-2A (non inclus). Matériaux : Aluminium - ABS. Marquage conseillé: laser - tampographie.

3-in-1 magnetic wireless charging station- For iPhone + Apple Watch + AirPods - Fast and secure connection in portrait or landscape mode - Charge up to 15W for iPhone 12 or newer - One charging surface on top compatible with most phones and devices that support wireless charging - Cool or warm white light + 7 colors - Dimmer - Touch control - Power supply: on USB-C port (cable included) and a Quick Charge 3.0 certified power adapter or a USB DC 9V-2A power adapter (not included). Material: Aluminum - ABS. Suggested branding: laser - pad print.





- CÂBLE USB-C VERS USB-C**

 USB-C TO USB-C CABLE
- 1,5 m**

 4.9 FT
- CHARGE RAPIDE JUSQU'À 100W**

 SUPPORTS FAST CHARGING UP TO 100W
- HAUTE QUALITÉ ET DURABLE**

 HIGH-QUALITY & DURABLE
- COMPATIBLE AVEC LA PLUPART DES APPAREILS MOBILES USB-C**

 COMPATIBLE WITH MOST USB-C MOBILE DEVICES

- MULTI PRISE**

 MULTI POWER SOCKET
- 4 PRISES**

 4 OUTLETS
- PORT USB-A ET USB-C POUR RECHARGER**

 USB-A & USB-C PORT TO RECHARGE

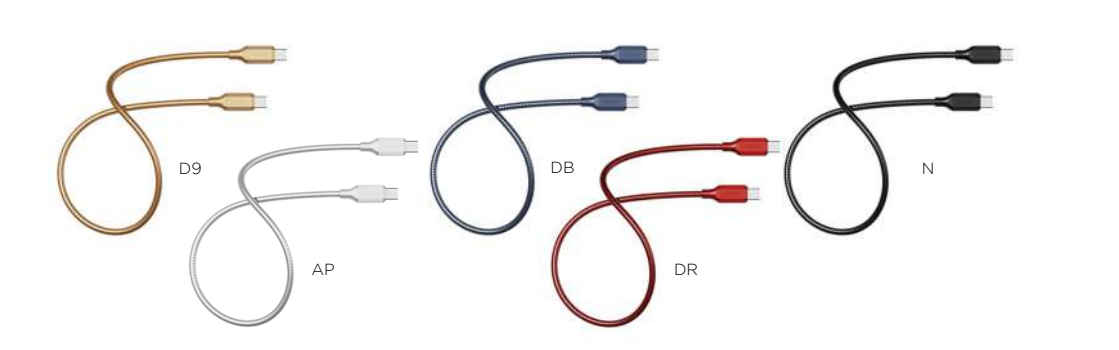

Câble USB-C - Câble de haute qualité et durable de 1,5m - Fonction magnétique cachée - Compatible avec la plupart des smartphones, tablettes et ordinateurs portables USB-C - Prend en charge une puissance de charge allant jusqu'à 20V / 5A / 100W. Matériaux : Métal - Cuir synthétique. Marquage conseillé : laser - tampographie.

USB-C cable - High-quality & durable 1.5m/4.9 ft cable - Magnetic suction function - Compatible with most USB-C smartphones, tablets, and laptops - Supports a charging power of up to 20V / 5A / 100W. Material: Metal - Synthetic leather. Suggested branding: laser - pad print.

Ø3,5 x 13,3 cm P.Brut : 156 g Ø1.38 x 5.24" G.W: 0.34 lbs	Colisage : 50 p/9,25 kg Carton: 50 p/20.4 lbs
--	--

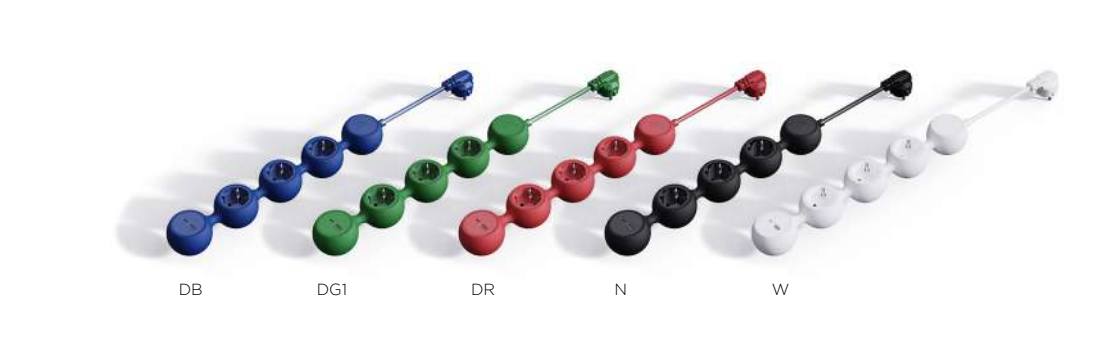

Multiprise quadruple avec double port USB-C - 4 prises pour les appareils électroniques tels que les ordinateurs, les smartphones ou d'autres appareils ménagers - Bouton interrupteur - Ports USB-A et USB-C 30W - Chargement simultané de plusieurs appareils - Protection contre les surtensions - Matériaux : PC. Marquage conseillé : laser - tampographie.

Power strip with dual USB-C ports - 4 AC outlets for electronic devices such as computers, smartphones or other household devices - Power switch button - 30W USB-A & USB-C ports - Charge multiple devices simultaneously - Surge protection - Material: PC. Suggested branding: laser - pad print.

Ø3,5 x 13,3 cm P.Brut : 156 g Ø1.38 x 5.24" G.W: 0.34 lbs	Colisage : 50 p/9,25 kg Carton: 50 p/20.4 lbs
--	--

WORK
TRAVAILLER



WORK TRAVAILLER

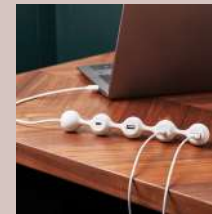

NEW

**PEAS
HUB-C**



**CITY
ENERGY
PRO**



**CITY
LIGHT**



MUSO

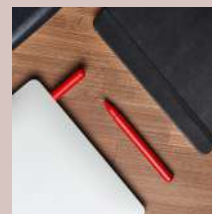

C-PEN



**C-PEN
STYLUS**



BEE 2

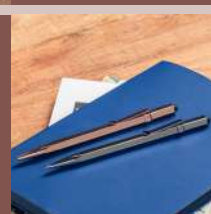

SCRIBALU



**NOMADAY
CARD**

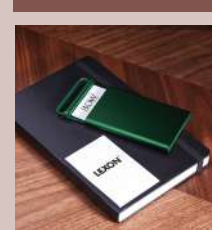

**CITY
COLLECTION**

PEAS HUB-C

Hub with USB-C connector for 2 USB-A ports + 2 USB-C ports
 Hub avec connectique USB-C pour 2 ports USB-A + 2 ports USB-C



Hub avec une connectique USB-C pour 2 ports USB-A + 2 ports USB-C - Câble intérieur cuivre -
 Matériaux : Gomme siliconée.

Hub with USB-C connector for 2 USB-A ports + 2 USB-C ports - Copper inside cable. Material: Silicone rubber.



Sérigraphie encre siliconée
 Silicone ink silkscreen

Ø 3,2 x 22,8 cm | P. Brut : 145 g
 Ø1.30 x 8.98»/ G.W: 0.32 lbs



Colisage : 40 p/6,2 kg
 Carton: 40 p/13,7 lbs



PEAS HUB-C
 Design by Valentina & Simone Spalvieri

CITY ENERGY PRO

Wireless charging station with Bluetooth® speaker & microphones
 Station de charge à induction avec enceinte Bluetooth® & microphones

CITY ENERGY PRO

Design by Manuela Simonelli & Andrea Quaglio



CHARGEUR SANS FIL RAPIDE 10W



10W WIRELESS FAST CHARGER

ENCEINTE BLUETOOTH®



BLUETOOTH® SPEAKER

DOUBLE MICROPHONE



DUAL MICROPHONE

OPTIMISÉ POUR LES CONFÉRENCES AUDIOS



OPTIMIZED FOR CONFERENCE CALLS

RÉDUCTION DU BRUIT AMBIANT



AMBIANT NOISE CANCELLING

FINITION ALUMINIUM & CUIR SYNTHÉTIQUE



ALUMINUM & SYNTHETIC LEATHER FINISHING



Station de recharge sans fil avec haut-parleur et Microphones Bluetooth® - Station de charge sans fil Qi 10W - Enceinte Bluetooth® - Compatible avec tous les smartphones compatibles à la recharge sans fil Qi - Audioconférences mains-libres - 2 microphones avec technologie de réduction du bruit ambiant - Se recharge sans fil - Voyants lumineux LED Bluetooth® - Version Bluetooth® : 5.0 | Distance Bluetooth® : 10m - Connexion : USB Type-C (câble inclus). Matériaux : Cuir synthétique - ABS - Aluminium.

Wireless charging station with Bluetooth® speaker & Microphones - 10W Qi wireless charging station - Bluetooth® speaker - Compatible with all Qi-enabled smartphones - Hands-free conference calls - Environment noise-cancelling microphones - Wireless charging & Bluetooth® LED lights indicator - Bluetooth® version: 5.0 | Bluetooth® distance: 10m - Connection: USB Type-C (cable included). Material: Synthetic leather - ABS - Aluminium.



DB

BZ

N

D9

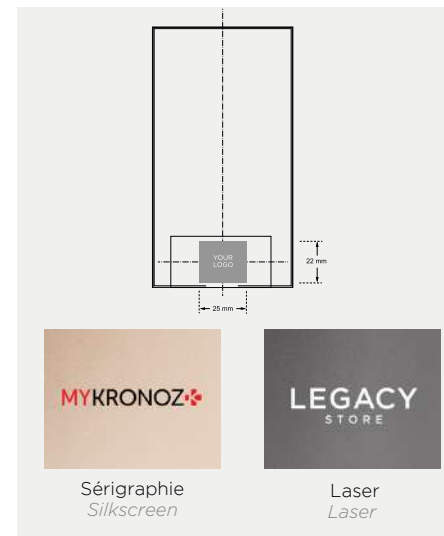

Sérigraphie
Silkscreen

Laser
Laser



Surface sans fil 7,9 x 3,7 x 14,3 cm | P.Brut : 400 g
 Wireless surface 3.11 x 1.46 x 5.63" | G.W: 0.88 lbs

Colisage : 20p/8,6 kg
 Carton: 20p/18.9 lbs

CITY LIGHT

Desk lamp with built-in speaker / microphones & wireless charger
 Lampe de bureau avec enceinte / microphones & chargeur à induction intégré

CITY LIGHT

Design by Manuela Simonelli & Andrea Quaglio



Lampe de bureau avec haut-parleur Bluetooth® et microphones - Station de charge sans fil Qi 10W - Enceinte Bluetooth® 3W - Compatible avec tous les smartphones compatibles à la recharge sans fil Qi - Audioconférences mains-libres - 2 microphones avec technologie de réduction du bruit ambiant - Batterie intégrée - Autonomie : 24h pour l'éclairage seul - Connexion : USB Type-C (câble inclus).
 Matériaux : ABS - Cuir synthétique.

Wireless charging desk lamp with Bluetooth® speaker & microphones - 10W Qi wireless charging station - 3W Bluetooth® speaker - Compatible with all Qi-enabled smartphones - Hands-free conference calls - Ambient noise-cancelling microphones - Operating with touch controls - Ideal position for video calls - Rechargeable battery built-in - Battery life: Up to 24h for lighting mode only - Charging time: 2h - Connection: USB Type-C (cable included). Material: ABS - Synthetic leather.

- | | | | | | | | | |
|-----------|-----------------------|-----------------------|--------------------|-------------------|---------------------|----------------------|-----------------------|------------|
| LAMPE LED | 9 COULEURS D'AMBIANCE | VARIATEUR D'INTENSITÉ | COMMANDES TACTILES | DOUBLE MICROPHONE | ENCEINTE BLUETOOTH® | CHARGEUR À INDUCTION | BATTERIE RECHARGEABLE | PORT USB-C |
| | | | | | | | | |
| LED LIGHT | 9 COLORS LIGHT | DIMMER | TOUCH CONTROLS | DUAL MICROPHONE | BLUETOOTH® SPEAKER | WIRELESS CHARGER | RECHARGEABLE BATTERY | USB-C PORT |



23 x 30 x 6.9 cm / P. Brut: 640 g
 9.05 x 12 x 2.72" / G.W: 1.41 lbs



MUSO

Bluetooth® wireless mouse / Souris sans fil Bluetooth®

MUSO

Design by Manuela Simonelli & Andrea Quaglio



Souris Bluetooth® sans fil et compacte avec pointeur laser - Deux boutons et une molette de défilement - Haute précision sur de multiples surfaces - Ambidextre - Ergonomie et design parfait - Batterie rechargeable - Autonomie : Jusqu'à 6 mois - Temps de charge : 3h - Rechargeable sur port USB Type-C (câble inclus). Matériaux : Cuir synthétique - ABS - Aluminium.

Compact Wireless mouse with premium finishing - Dual buttons and precise scroll wheel - High precision on multiple surfaces - Ambidextrous - Perfect ergonomic design - Rechargeable battery - Battery life: Up to 6 months - Charging time: 3h - Rechargeable on USB Type-C port (cable included). Material: Synthetic leather - ABS - Aluminum.



DG1



R



N



DB



D



X

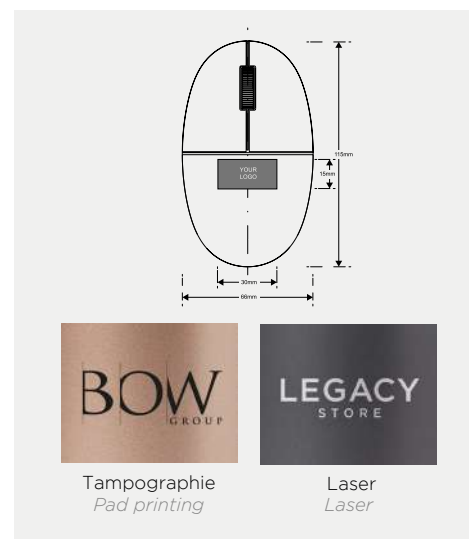

11,5 x 6,7 x 3,1 cm / P. Brut : 150 g
4,33 x 2,36 x 1,18 / G.W: 0.33 lbs



Colisage: 20 pcs / 3,8 kg
Carton: 20 pcs/ 8,38 lbs

C-PEN

Ballpoint pen with 32Bb USB-C drive / *Stylo bille avec clé USB-C 32Go*

C-PEN

Design by Alain Berteau

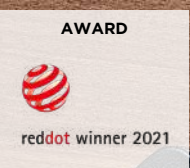

STYLO À BILLE
À ENCRE NOIRE
RECHARGE UNIVERSELLE



BLACK INK
BALLPOINT PEN
UNIVERSAL REFILL

CONNECTEUR
USB-C



USB-C
DRIVE

CAPACITÉ
DE 32GO



32GB
CAPACITY

COMPATIBLE AVEC
LES ORDINATEURS, TABLETTES
ET SMARTPHONES USB-C



COMPATIBLE WITH USB-C
COMPUTERS, TABLETS
AND SMARTPHONES



Stylo bille avec clé USB-C 32Go - Recharge universelle Connecteur USB-C - Capacité de 32Go - Stockez jusqu'à 4 000 photos, 7000 chansons ou 40h de vidéos - Compatible : Windows 7,8 & 10 / Max OS X v10.6 et supérieur. Matériaux : Acier inoxydable pour clip - Corps principal en ABS.

Ballpoint pen with 32GB USB-C drive - Universal refill - USB-C connector - Capacity of 32GB - Save up to 4,000 pictures, 7,000 songs or 40h of video - Compatible: Windows 7,8 & 10 / Mac OS X v10.6 and higher - Material: Stainless steel for clip - ABS main body.



N

WG

DR

DB

PF

YF

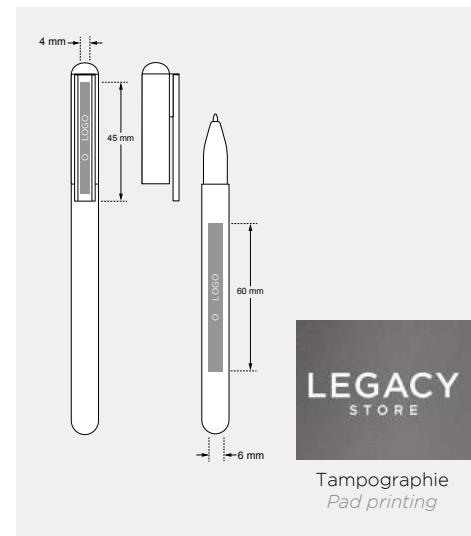

Ø1,1 x 15,6 cm | P.Brut : 71.8 g
Ø0,43 x 6,14" | G.W: 0.16 lbs



Colisage : 50 p/4,3 kg
Carton: 50 p/9,6 lbs

C-PEN STYLUS

Stylus with 32Gb USB-C drive / *Styleret avec clé USB-C 32Go*

C-PEN STYLUS

Design by Alain Berteau



STYLET POUR APPAREILS
AVEC ÉCRAN TACTILE



STYLUS FOR TOUCHSCREEN
DEVICES

CONNECTEUR
USB-C



USB-C
DRIVE

CAPACITÉ
DE 32GO



32GB
CAPACITY

COMPATIBLE AVEC
LES ORDINATEURS, TABLETTES
ET SMARTPHONES USB-C



COMPATIBLE WITH USB-C
COMPUTERS, TABLETS
AND SMARTPHONES

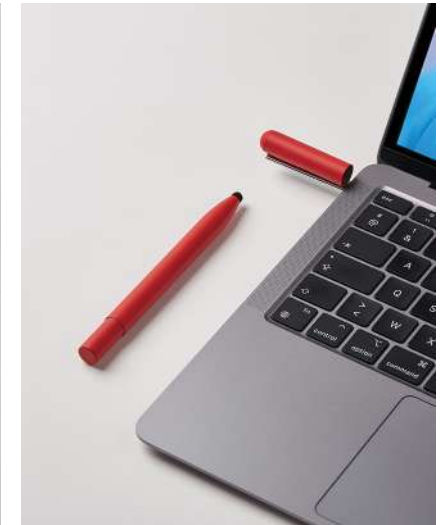

Stylus avec mémoire flash USB-C - Recharge universelle - Connecteur USB-C - Capacité de 32 Go - Compatible : Windows 7,8 & 10 / Max OS X v10.6 et supérieur. Matériaux : Acier inoxydable pour clip - Corps principal en ABS.

Ballpoint pen with 32GB USB-C drive - Universal refill - USB-C connector - Capacity of 32GB - Save up to 4,000 pictures, 7,000 songs or 40h of video - Compatible: Windows 7,8 & 10 / Mac OS X v10.6 and higher - Material: Stainless steel for clip - ABS main body



N



WG



DR



DB

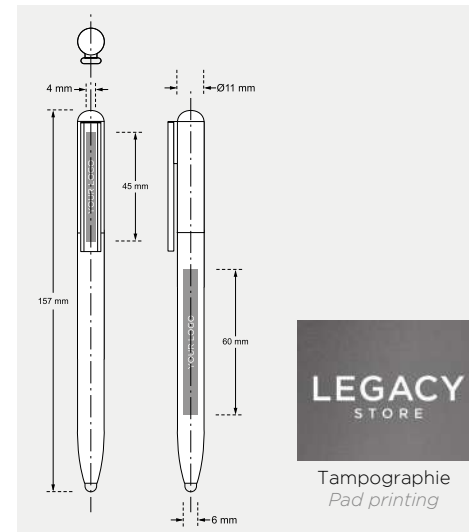

Ø 1,1 x 15,6 cm | P. Brut : 75 g
Ø 0.43 x 6.14" | G.W: 0.20 lbs



Colisage : 50 p/4,3 kg
Carton : 50 p/9.6 lbs

BEE 2

Twisting ballpoint pen & stylus / *Stylo à bille rotatif & stylet*
Design by Lexon Studio

**SCRIBALU**

Rollerball pen on base / *Stylo roller sur socle*
Design by Lexon Studio



Stylo à bille rotatif 2-en-1 / Stylet - Recharge universelle - Matériaux : Laiton. Marquage conseillé : sérigraphie - laser.

2-in-1 twist ballpoint pen / stylus - Universal refill - Material: Brass. Suggested branding: silkscreen - laser.

Ø 0,8 x 14,2 cm | P. Brut : 65 g
Ø 0.3 x 5.6" | G.W: 0.14 lbs

Colisage : 100 p/5,7 kg | s/c : 50 p/3 kg
Carton: 100 p/12.57 lbs | i/c: 50 p/16 oz

Colors on request / *Couleurs sur demande*



Stylo roller sur socle - Recharge universelle - Matériaux : Aluminium. Marquage conseillé : sérigraphie - laser.

Rollerball pen on a base - Universal refill - Material: Aluminum. Suggested branding: laser - silkscreen.

Ø 4 x 18 cm | P. Brut : 170 g
Ø 1.6 x 7» | G.W: 0.37 lbs

Carton: 50 p/8,9 kg | i/c: 25 p
Carton: 50 p/19.8 lbs | i/c: 25 p

NOMADAY CARD

Case for 15 business cards / Étui pour 15 cartes de visite

Design by Guillaume Delvigne



DG1



DR



N



DB



D



X

Étui pour 15 cartes de visite - Matériaux : Aluminium - ABS. Marquage conseillé : sérigraphie - laser.

Business card case for 15 cards - Material: Aluminum - ABS. Suggested branding: Silkscreen - Laser.

6,4 x 1 x 11,4 cm | P. Brut : 75 g
2.52 x 0.39 x 4.49" | G.W: 0.16 lbs

Colisage : 60 p/ 5,4 kg | s/c: 20 p
Carton: 60 p/ 11.9 lbs | i/c: 20 p



CITY COLLECTION

Design by Manuela Simonelli & Andrea Quaglio

CITY COLLECTION

Design by Manuela Simonelli & Andrea Quaglio



**LD135
RULER**



Règle de 20 cm - Matériaux :
aluminium. Marquage conseillé :
sérigraphie - laser.

*20 cm ruler - Material:
Aluminum. Suggested
branding: silkscreen - laser.*

23,5 x 3,2 x 0,9 cm / P. Brut :
63 g / Colisage : 100 p / 7,5 kg
9.2 x 1.2 x 0.3" / G.W: 0.14 lbs /
Carton: 100 p / 16.5 lbs



**LD139
TAPE DISPENSER**



Dévidoir de ruban adhésif -
Rouleau adhésif mat fourni
- Matériaux : aluminium.
Marquage conseillé :
sérigraphie - laser.

*Desk tape dispenser - Matt
tape included - Material:
Aluminum. Suggested
branding: silkscreen - laser.*

9,7 x 4 x 5,5 cm / P. Brut : 181 g /
Colisage : 40 p / 8,7 kg
3.8 x 1.6 x 2.1" / G.W: 0.4 lbs /
Carton : 40p / 19 lbs



**LD138
DESK TRAY**



Vide poche - 4 compartiments
- Matériaux : aluminium.
Marquage conseillé :
sérigraphie - laser - impression
numérique.

*Round desk tray -
4 compartments - Material:
Aluminum. Suggested
branding: silkscreen - laser -
digital printing.*

Ø 10,2 x 2,9 cm / P. Brut : 110 g /
Colisage : 40 p / 7,5 kg
Ø 4 x 1.1" / G.W: 0.31 lbs /
Carton: 40 p / 16 lbs



**LD137
CARD STAND**



Support pour cartes de
visite - Matériaux : aluminium.
Marquage conseillé :
sérigraphie - laser.

*Business card holder
- Material: Aluminum.
Suggested branding:
silkscreen - laser.*

10,3 x 7,9 x 5,4 cm / P. Brut : 84 g /
Colisage : 40 p / 4,7 kg
4 x 3.1 x 2.1" / G.W: 0.2 lbs /
Carton: 40 p / 10.8 lbs



**LD140
PEN CUP**

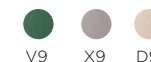

Pot à crayons - Matériaux
: aluminium. Marquage
conseillé : sérigraphie - laser.

*Pen cup - Material: Aluminum.
Suggested branding:
silkscreen - laser.*

Ø 7 x 8,8 cm / P. Brut : 153 g /
Colisage : 40 p / 7,6 kg
Ø 2.7 x 3.4" / G.W: 0.34 lbs /
Carton: 40 p / 17 lbs



**LD14
CARD BOX**

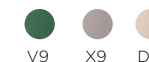

Étui pour 20 cartes de visite -
Matériaux : aluminium anodisé.
Marquage conseillé : sérigraphie
sur laser - embossage en
fabrication spéciale.

*Business card case for
20 cards - Material: Anodised
aluminum. Suggested branding:
silkscreen - laser - special
production embossing.*

9,3 x 6,1 x 0,9 cm / P. Brut : 38 g /
s/c : 100 p / 3 kg / Colisage : 300
p / 12,840 kg
3.7 x 2.4 x 0.3" / G.W: 0.1 lbs /c:
100 p / Carton: 300 p / 28 lbs.

MOVE
SE DÉPLACER



MOVE *SE DÉPLACER*

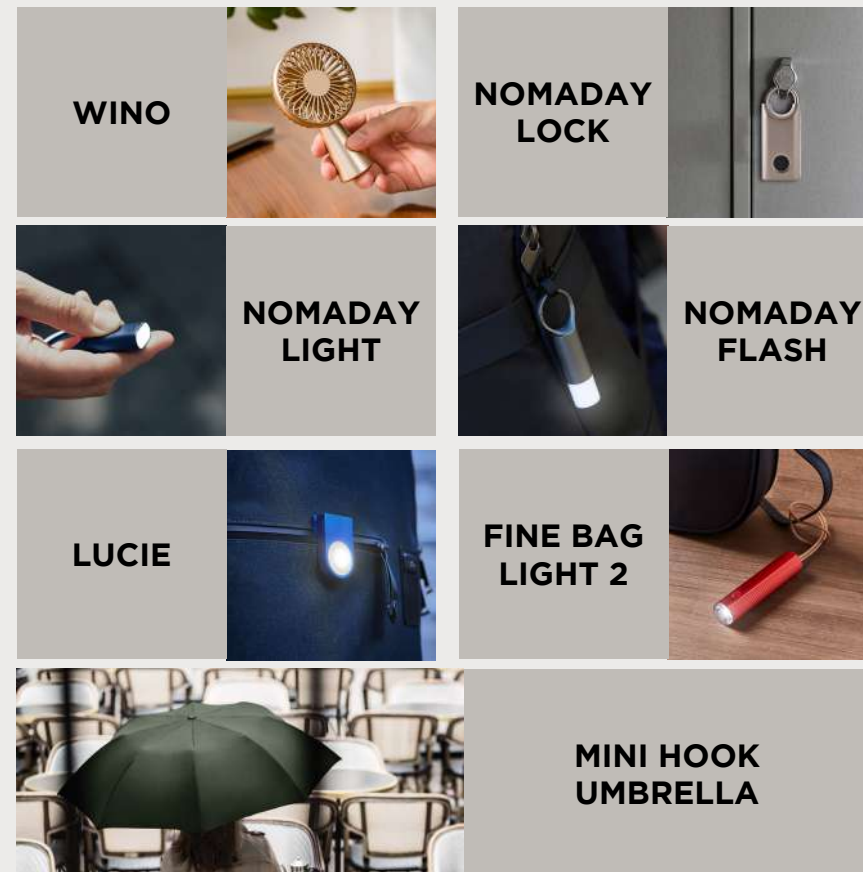

WINO

Mini portable fan / Mini ventilateur portable



3 VITESSES
AJUSTABLES



3 ADJUSTABLE
SPEEDS

PALES ULTRA
SILENCIEUSES



ULTRA-QUIET
BLADES

JUSQU'À 5H
D'AUTONOMIE



UP TO 5H
BATTERY LIFE

RECHARGEABLE
PAR INDUCTION



WIRELESSLY
RECHARGEABLE

RECHARGEABLE
PAR USB-C



RECHARGEABLE
VIA USB-C

BASE EN
ALUMINIUM



ALUMINIUM
BASE



New colors 2023 / Nouvelles couleurs 2023

WINO

Design by Manuela Simonelli & Andrea Quaglio



Mini ventilateur portable avec recharge par induction - 3 vitesses de ventilation - Pales ultra silencieuses - Jusqu'à 5h d'autonomie - Temps de charge : 2h - Rechargeable par induction - Port USB-C - Matériaux : base en aluminium & tête en ABS.

Mini hand-held fan with wireless charge - 3 Airflow speeds - Ultra-quiet blades - Up to 5h battery life - Charging time: 2h - Wirelessly rechargeable - USB-C port - Material: Aluminum base & ABS head.

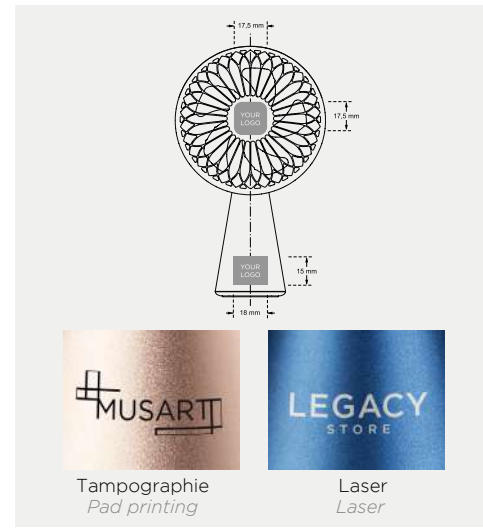

13,2 x 4,8 x 7,9 cm | P. Brut : 220 g
5.19 x 1.88 x 3.11" | G.W: 0.5 lbs



Colisage : 36p/7,96 kg
Carton: 36 p/15.4 lbs

NOMADAY LOCK

Biometric fingerprints padlock / Cadenas biométrique à empreintes digitales

NOMADAY LOCK

Design by Guillaume Delvigne



- OUVERTURE EN MOINS DE 0.5 SEC**
UNLOCKING IN LESS THAN 0.5 SEC
- ENREGISTRE JUSQU'À 10 EMPREINTES DIFFÉRENTES**
STORE UP TO 10 DIFFERENT FINGERPRINTS
- RÉSISTANT À LA PLUIE IP65**
IP65 RAIN-PROOF
- JUSQU'À 12 MOIS D'AUTONOMIE**
UP TO 12 MONTHS BATTERY LIFE
- RECHARGEABLE PAR USB-C**
RECHARGEABLE VIA USB-C

Cadenas biométrique à empreintes digitales - Usage intérieur/extérieur - Ouverture en moins de 0.5 seconde - Enregistre jusqu'à 10 empreintes différentes - Indicateur LED - Autonomie : jusqu'à 3000 déverrouillages après une charge complète / Autonomie en veille : jusqu'à 12 mois - Temps de charge : 1h30 - Rechargeable sur port USB-C (câble inclus) - Résistance à l'eau : IP65 Matériaux : Bague en acier inoxydable et corps en alliage de zinc.

Biometric fingerprints padlock - Indoor/Outdoor use - Unlocking in less than 0.5 second - Stores up to 10 different fingerprints - LED indicator - Battery life: up to 3000 unlock times after full charge / Stand by time: up to 12 months - Charging time: 1.5h - Rechargeable on USB-C port (cable included) - Water resistance: IP65 - Material: Stainless steel ring and Zinc alloy body.

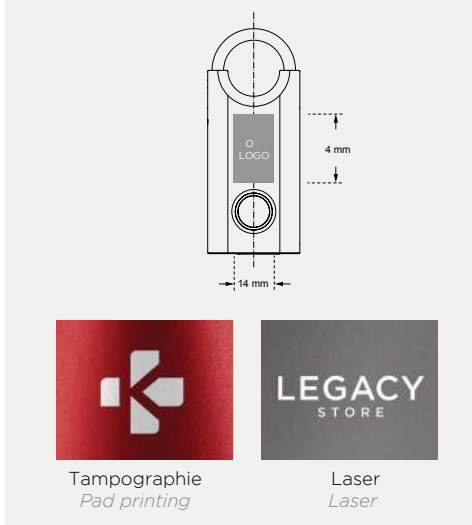

3,2 x 1,4 x 7,6 cm | P.Brut : 140 g
1.25 x 0.55 x 2.99" | G.W: 0.31 lbs

Colisage : 40p/6.38 kg | s/c: 20p
Colisage: 40 p/ 14.1 lbs | s/c: 20

LL136

NOMADAY LIGHT

Mini LED torch keyring with clip / Porte-clés mousqueton avec mini torche LED
Design by Guillaume Delvigne



- LUMIÈRE LED BLANCHE**
 WHITE LED LIGHT
- VISIBLE JUSQU'À 50 M**
 VISIBLE UP TO 50M
- MOUSQUETON INTÉGRÉ**
 BUILT-IN CLIP
- JUSQU'À 1H D'AUTONOMIE**
 UP TO 1H BATTERY LIFE
- RECHARGEABLE PAR USB-C**
 RECHARGEABLE VIA USB-C
- FINITION ALUMINIUM**
 ALUMINIUM FINISHING



Porte-clés mousqueton avec mini torche LED - Lumière visible jusqu'à 50 mètres - Temps de charge : 1h - Rechargeable sur port USB-C (câble inclus) - Matériaux : ABS - Alliage de zinc - Acier inoxydable. Marquage conseillé : laser - sérigraphie.

Mini LED torch keyring with hook - Visible light up to 150 feet - Charging time: 1h - Rechargeable on USB-C port (cable included) - Material: ABS - Zinc Alloy - Stainless steel. Suggested branding: laser - pad print.

3,2 x 1 x 6 cm | P.Brut : 62 g
1,25 x 0.39 x 2.36" | G.W: 0.14 lbs

Colisage : 80p/5,6 kg | s/c: 40p
Colisage: 80 p/ 12.3 lbs | s/c: 40

LL137

NOMADAY FLASH

Wearable LED lamp with clip / Lampe LED de signalisation avec mousqueton
Design by Guillaume Delvigne



- LED ROUGE OU BLANCHE 4 MODES D'ÉCLAIRAGE**
 RED OR WHITE LED WITH 4 LIGHTING MODES
- VISIBLE JUSQU'À 200 M**
 VISIBLE UP TO 200M
- MOUSQUETON INTÉGRÉ**
 BUILT-IN CLIP
- JUSQU'À 12H D'AUTONOMIE**
 UP TO 12H BATTERY LIFE
- RECHARGEABLE PAR USB-C**
 RECHARGEABLE VIA USB-C
- FINITION ALUMINIUM**
 ALUMINIUM FINISHING
- IPX4 HAUTE RÉSISTANCE À LA PLUIE**
 HIGH RESISTANCE RAIN-PROOF IPX4



Lampe LED de signalisation avec mousqueton - Lumière rouge ou blanche Fixe ou clignotante - Résistance à la pluie IPX4 - Lumière visible jusqu'à 200 mètres - Autonomie : 12h - Temps de charge : 1h30 - Rechargeable sur port USB-C (câble inclus) - Matériaux : ABS - Alliage de zinc - Acier inoxydable. Marquage conseillé : laser - sérigraphie.

Wearable LED lamp with clip - Red or white light - Fixed or blinking - IPX4 Rain resistant - Visible light up to 600 feet - Battery life: 12h - Charging time: 1.5h - Rechargeable on USB-C port (cable included) - Material: ABS - Zinc Alloy - Stainless steel. Suggested branding: laser - pad print.

3,2 x 1,8 x 10 cm | P.Brut : 115 g
1,25 x 0.70 x 3.93" | G.W: 0.25 lb

Colisage : 40p/5,4 kg | s/c: 20p
Colisage: 40 p/ 14.1 lbs | s/c: 20

LL121

LUCIE

Wearable LED clip / *Clip LED de signalisation*
Design by Yoann Jacquon



LL129

FINE BAG LIGHT 2

LED bag light / *Lampe LED pour sac à main*
Design by Pauline Deltour



LAMPE
LED



LED
LIGHT

VISIBLE
JUSQU'À 150 M



VISIBLE
UP TO 150M

CLIP COMPACT
ET ULTRA STABLE



COMPACT &
SECURE CLIP

RÉSISTANCE
À LA PLUIE



RAIN
RESISTANT

RECHARGEABLE
PAR USB-C



RECHARGEABLE
VIA USB-C

LAMPE
LED



LED
LIGHT

RECHARGEABLE
PAR USB-C



RECHARGEABLE
VIA USB-C

FINITION
ALUMINIUM



ALUMINIUM
FINISHING



B

D

X

R

N



D

X

R

Clip LED de signalisation - Lumière blanche ou rouge - Fixe ou clignotante - Rechargeable - Résistance à la pluie IPX4 - Lumière visible jusqu'à 150 mètres - Autonomie : jusqu'à 12h - Temps de charge : 2h - Rechargeable sur port USB-C (câble inclus). Matériaux : Aluminium - ABS. Marquage conseillé : sérigraphie.

Wearable LED clip - Red or white light - Fixed or blinking Rechargeable Rain resistance IPX4 - Visible light up to 500 feet Battery life: up to 12h - Charging time: 2h - Rechargeable on USB-C port (cable included) Material: Aluminum- ABS. Suggested branding: silkscreen.

3,1 x 1,3 x 4,8 cm | P.Brut : 50 g
1,22 x 0,51 x 1,89" | G.W: 0,12 lbs

Colisage : 80p/5,6 kg | s/c: 40p
Colisage: 80 p/ 12.3 lbs | s/c: 40

Lampe pour sac à main - LED ultra lumineuse - Autonomie : jusqu'à 4 heures après une charge complète - Autonomie en veille : jusqu'à 6 mois - Temps de charge : 1,5h - Rechargeable sur port USB-C (câble inclus) - Matériaux : Aluminium - ABS - Cuir. Marquage conseillé : laser - tampographie.

Bag light - Super bright LED - Battery life: up to 4 hours after a full charge - Standby time: up to 6 months - Charging time: 1,5h - Rechargeable on USB-C port (cable included). Material: Aluminum - ABS - Leather. Suggested branding: laser - pad print.

Ø2,2 x 9,6cm | P.Brut : 107 g
Ø0,87 x 3,78" | G.W: 0,23 lbs

Colisage : 50p/5,6 kg
Carton: 50 p/12.3 lbs

MINI HOOK UMBRELLA

Design by Theo Williams



M1 LP LL



R O1 J8 B LB1 K9 N6 G3

Parapluie pliable 2 sections - Poignée mousqueton - Matériaux : Axe aluminium - Toile polyester - Poignée ABS gomme. Marquage conseillé : sérigraphie.

Foldable umbrella 2 sections -hookhandle - Material: Aluminum shaft - Polyester fabric - ABS rubberhandle. Suggested branding: silkscreen.

Fermé Ø 5 x 51 cm / Ouvert Ø 122 x 50 cm | P. Brut : 410 g
 Closed Ø 1.96 x 20.07" / Open Ø 48.03 x 20.07" | G.W: 0.94 lbs

Colisage : 24 p/11,240 kg | s/c: 12p
 Colisage: 24 p/ 24.8 lbs | s/c: 12

New colors 2023 / Nouvelles couleurs 2023



CARRY TRANSPORTER



YOU CARRY, WE CARE

At Lexon, we are committed to offer durable solutions by sourcing innovative and responsible materials.

2023 marks the beginning of our move towards sustainability as we will progressively shift our entire bag category to be made in environmentally-friendly fabrics such as rPET.

Chez Lexon, nous nous engageons à offrir des solutions durables en sélectionnant des matériaux innovants et responsables. 2023 marque le début de notre évolution vers la durabilité ; la transformation de l'ensemble de notre catégorie bagagerie est en marche, avec pour objectif de fabriquer toutes nos collections dans des tissus respectueux de l'environnement tels que le rPET.

CARRY TRANSPORTER



ONE+

PREMIUM+



TRACK

CHALLENGER



EVE

TERA



PEANUT

PACKABLE





**LC2806
TECH POUCH**



**LC2807
TECH ORGANIZER**



**LC2808
MINI POUCH**



Pochette à bandoulière pour smartphone avec 2 compartiments

11 x 2,5 x 20 cm / P. Brut: 120 g

Sling pouch for smartphone with 2 compartments

4.33 x 0.98 x 7.87" / G.W: 0.26 lbs

Pochette pour accessoires électroniques - Ouverture à plat

19 x 8,5 x 11 cm / P. Brut: 100 g

Pouch for electronic accessories - Flat opening

7.48 x 3.35 x 4.33" / G.W: 0.22 lbs

Pochette dotée d'une dragonne

21 x 5 x 12 cm / P. Brut: 80 g

Pouch with wrist strap

8.27 x 1.97 x 4.72" / G.W: 0.18 lbs

LC2800 BACKPACK / LC2803 DOUBLE BACKPACK



15"

16"

Sac à dos - Compartiment pour ordinateur jusqu'à 16" - Capacité: 14 L

28 x 13 x 38 cm / P. Brut: 550 g / Colisage: 24 pcs / 13.2 kg

Sac à dos double - Compartiment pour ordinateur jusqu'à 16" - Capacité: 15 L

28 x 14 x 38 cm / P. Brut: 560 g / Colisage: 24 pcs / 13.4 kg

Backpack - Compatible up to 16" laptop - Capacity: 14 L

11.02 x 5.12 x 14.96" / G.W: 1.21 lbs / Carton: 24 pcs / 29.10 lbs

Double laptop backpack - Compatible up to 16" laptop - Capacity: 15 L

11.02 x 5.51 x 14.96" / G.W: 1.23 lbs / Carton: 24 pcs / 29.54 lbs

LC2801 2 IN 1 DOCUMENT BAG



14"



Porte-documents convertible en sac à dos - Compartiment pour ordinateur 14" - Poignées rétractables - Sangles dissimulables - Fermetures gomme étanche - Capacité : 5 L

38 x 5,5 x 26,5 cm / P. Brut: 475 g / Colisage: 24p / 11.4 kg

Convertible briefcase into backpack - 14" laptop compartment - Retractable handles - Concealable handles - Waterproof rubber zippers Capacity: 5 L

14.96 x 2.16 x 10.4" / G.W: 1.05 lbs / Carton: 24p / 25.13 lbs

LC2802 DOCUMENT BAG



15"

16"



Porte-documents et ordinateur - Compartiment pour ordinateur jusqu'à 16" - Bandoulière - Capacité : 17 L

41,5 x 9 x 31 cm / P. Brut: 420 g / Colisage: 24p / 10.6 kg

Laptop document bag - Compatible up to 16" laptop - Shoulder strap - Capacity: 17 L

16.34 x 3.54 x 12.20" / P. Brut: 0.93 lbs / Carton: 24p / 23.37 lbs

LC2804 SLIM LAPTOP BAG



13"

14"



Porte-documents et ordinateur - Compartiment pour ordinateur jusqu'à 14" - Capacité: 5 L

37 x 5 x 29 cm / P. Brut: 350 g / Colisage: 24p / 8.4 kg

Laptop document bag - Compatible up to 14" laptop - Capacity: 5 L

14.57 x 1.97 x 11.42" / G.W: 0.77 lbs / Carton: 24p / 18.52 lbs

LC2805 DUFFLE BAG



Sac de voyage - Base renforcée - Capacité: 30 L

45 x 23 x 30 cm / P. Brut: 550 g / Colisage: 12p / 6.6 kg

Travel bag - reinforced base - Capacity: 30 L

17.71 x 9.05 x 11.81 / G.W: 1.21 lbs / Carton: 12p / 14.55 lbs



LN2700 A4 FOLDER



Conférencier A4 - Bloc-notes 50 feuilles
33 x 2 x 25 cm / P. Brut: 850 g / Colisage: 12p / 10.4 kg
A4 blinder - 50 pages memo pad
12.99 x 0.78 x 9.84" / G.W: 1.87 lbs / Carton: 12p / 22.92 lbs

LN2702 MEDIUM LAPTOP BAG



Porte-documents et ordinateur - Compartiment pour ordinateur jusqu'à 14" - Bandoulière large - 2 poignées en aluminium - Capacité: 6 L
36 x 6.5 x 27.5 cm / P. Brut: 570 g / Colisage: 12p / 6.8 kg
Laptop document bag - Compatible up to 14" laptop - Wide shoulder strap - 2 aluminium handles - Capacity: 6 L
14.2 x 2.5 x 10.8" / G.W: 1.25 lbs / Carton: 12p / 14.99 lbs

LN2701 SLIM LAPTOP BAG



Porte-documents et ordinateur - Compartiment pour ordinateur jusqu'à 14" - Capacité: 5 L
37 x 5 x 26 cm / P. Brut: 280 g / Colisage: 24p / 6.7 kg
Laptop document bag - Compatible up to 14" laptop - Capacity: 5 L
14.57 x 1.97 x 10.24" / G.W: 0.62 lbs / Carton: 24p / 14.77 lbs

LN2703 LARGE LAPTOP BAG



Porte-documents et ordinateur - Compartiment pour ordinateur jusqu'à 16" - Bandoulière large - 2 poignées en aluminium - Capacité: 10 L
40 x 9 x 30.5 cm / P. Brut: 640 g / Colisage: 12p / 7.7 kg
Laptop document bag - Compatible up to 16" laptop - Wide shoulder strap - 2 aluminium handles - Capacity: 10 L
15.74 x 3.54 x 12.01" / G.W: 1.41 lbs / Carton: 12 p / 16.97 lbs

LN2704 SLIM BACKPACK



Sac à dos - Compartiment pour ordinateur jusqu'à 14" - Capacité: 16 L
29 x 14 x 40 cm / P. Brut: 480 g / Colisage: 12p / 5.7 kg
Backpack - Compatible up to 14" laptop - Capacity: 16 L
11.42 x 5.51 x 15.75" / G.W: 1.06 lbs / Carton: 12p / 12.57 lbs

LN2705 DOUBLE BACKPACK



Sac à dos double - Compartiment pour ordinateur jusqu'à 16" - Capacité: 17 L
29 x 14.5 x 40 cm / P. Brut: 610 g / Colisage: 12 pcs / 7.3 kg
Double laptop backpack - Compatible up to 16" laptop - Capacity: 17 L
11.42 x 5.70 x 15.7" / 1.34 lbs / Carton: 12 pcs / 16.09 lbs

LN2706 DUFFLE BAG



Sac de voyage - Base renforcée - 2 poignées en aluminium - Capacité: 32 L
45 x 23.5 x 30.5 cm / 670 g / Colisage: 12p / 8 kg
Travel bag - reinforced base - Capacity: 32 L
17.72 x 9.25 x 12.01 / 1.47 lbs / Carton: 12p / 17.64 lbs

LN2707 TOILETRY BAG



Trousse de toilette - Capacité: 3.5 L
22.5 x 16.5 x 16 cm / P. Brut : 320 g / Colisage : 36p / 11.5 kg
Toiletry bag - Capacity: 3.5 L
8.9 x 6.5 x 6.3" / G.W: 0.7 lbs / Carton: 36 p / 25.3 lbs



LN2406 15" DOCUMENT BAG

15"



B N K G

Porte-documents et ordinateur - Compartiment pour ordinateur 15" - Bandoulière - Capacité: 11 L

40 x 10 x 29 cm / P. Brut : 560 g / Colisage : 20 p / 11.20 kg

Laptop document bag - 15" laptop compartment - Shoulder strap - Capacity: 11 L

5.7 x 3.9 x 11.4" / G.W: 1.23 lbs / Carton: 20 p / 24.69 lbs

LN2404 DOCUMENT BACKPACK

15"



B
N
K
G

Porte-documents et sac à dos - Compartiment pour ordinateur 15" - Capacité: 12 L

29 x 10.5 x 42 cm / P. Brut: 860 g / Colisage: 8p / 6.9 kg

Document bag & Backpack - 15" laptop compartment - Capacité: 12 L

11.42 x 4.13 x 16.53 / G.W: 1.89 lbs / Carton: 8p / 15.21 lbs

LN2405 ENVELOP BRIEF

15"



B
N
K
G

Porte-documents et ordinateur - Compartiment pour ordinateur 15"

40 x 4 x 28 cm | P. Brut: 420 g | Colisage: 20 p / 8.40 kg

Laptop document bag - 15" laptop compartment

15.7 x 1.6 x 11" | G.W: 0.92 lbs / Carton: 8 p / 18.51 lbs

LN2400 A4 FOLDER



B
N
K
G

Conférencier A4 - Fermeture à glissière

24 x 2 x 33 cm / P. Brut: 470 g / Colisage: 20 p / 10.70 kg

A4 folder - Zipper closure

9.4 x 0.8 x 13" / G.W: 1.04 lbs / Carton: 20 p / 23.59 lbs

LN2401 LAPTOP BRIEF

13"

14"



Porte-documents et ordinateur - Compartiment pour ordinateur jusqu'à 14"

40 x 3 x 27cm / P. Brut: 420 g / 20p / 8.40 kg

Laptop document bag - Compatible up to 14" laptop

15.74 x 1.18 x 10.63" / G.W: 0.92 lbs / Carton: 20 p / 18.52 lbs

LN2402 SIMPLE BACKPACK

13"

14"



B
N
K
G

Sac à dos - Compartiment pour ordinateur jusqu'à 14" - Capacité: 18 L

28 x 16 x 40 cm / P. Brut: 590 g / Colisage: 8p / 4.7 kg

Backpack - Compatible up to 14" laptop - Capacity: 18 L

11.02 x 6.29 x 15.75" / G.W: 1.30 lbs / Carton: 8p / 10.36 lbs

LN2403 DOUBLE BACKPACK

13"

14"



B
N
K
G

Sac à dos double - Compartiment pour ordinateur jusqu'à 14" - Capacité: 20 L

28 x 18 x 40 cm / P. Brut: 690 g / Colisage: 8p / 5.5 kg

Double backpack - Compatible up to 14" laptop - Capacity: 20 L

11.02 x 7.09 x 15.75" / G.W: 1.52 lbs / Carton: 8p / 12.12 lbs



CHALLENGER

Design by Marco Pulga & Luca Artioli

CHALLENGER

Design by Marco Pulga & Luca Artioli



N

B

BG

W

LC654 BACKPACK



15"

16"



- N
- B
- BG
- W

Sac à dos double - Compartiments pour ordinateur jusqu'à 16" et tablettes - Dos renforcé - Poignée rétractable - Sangles dissimulables - Fermetures gomme étanche - Capacité : 20 L

30 x 17 x 40 cm / P. Brut : 890 g / Colisage : 6 p / 5.3 kg

Double backpack - Compatible up to 16" laptop & tablet compartments - Reinforced back - Retractable handle - Concealable handles Waterproof rubber zippers - Capacity: 20 L

11.8 x 6.7 x 15.7" | G.W: 1.96 lbs / Carton: 6 p / 11.68 lbs

LC662 DOCUMENT BACKPACK



15"

16"



- N
- B
- BG
- W

Porte-documents convertible en sac à dos - Compartiments ordinateur 16" et tablettes - Poignées rétractables - Sangles dissimulables - Fermetures gomme étanche - Capacité : 12 L

30 x 10 x 41 cm / P.Brut: 900 g / Colisage: 12p / 10.8 kg

Convertible briefcase into backpack - 16" laptop & tablet compartments Retractable handles - Concealable handles Waterproof rubber zippers - Capacity: 12 L

11.8 x 3.9 x 16.1" | G.W: 2 lbs / Carton: 12 p / 23.8 lbs

LC663 LAPTOP BRIEF



16"

- N
- B
- BG
- W

Porte-documents extra plat pour ordinateur 15" - Fermetures gomme étanche

39 x 2 x 28 cm / P.Brut: 430 g / Colisage: 20p / 8.6 kg

Extra-slim 15" laptop document bag - Waterproof rubber zippers

15.4 x 0.8 x 11" | G.W: 0.94 lbs / Carton: 20 p / 18.96 lbs

LC664 13" LAPTOP BRIEF



13"

- N
- B
- BG
- W

Porte-documents extra plat pour ordinateur 13" - Fermetures gomme étanche

36.5 x 2 x 25 cm / P.Brut: 420 g / Colisage: 20p / 8.4 kg

Extra-slim 13" laptop document bag - Waterproof rubber zippers

14.37 x 0.78 x 9.84" / G.W: 0.92 lbs / Carton: 20 p / 18.51 lbs

LC651 DOCUMENT BAG



13"

14"

- N
- B
- BG
- W

Porte documents et ordinateur - Compartiment pour ordinateur jusqu'à 14" - Poignées rétractables - Poches zippées en façade

40 x 30.5 x 6.5 cm / P. Brut : 590 g / Colisage : 18 p / 10.6 kg

Laptop document bag - Compatible up to 14" laptop - Retractable handles - Front zip pockets

15.7 x 11.8 x 2.5 / G.W: 1.3 lbs / Carton: 18 p / 23.37 lbs

LC652 DOCUMENT BAG



15"

16"

- N
- B
- BG
- W

Porte documents et ordinateur - Compartiment ordinateur jusqu'à 16" - Poignées rétractables - Poches zippées en façade

40 x 30 x 9 cm / P.Brut: 820 g / Colisage: 12p / 10.8 kg

Laptop document bag - Compatible up to 16" laptop - Retractable handles - Front zip pockets

15.7 x 11.6 x 3.7 / G.W: 1.80 lbs / Carton: 12 p / 23.81 lbs

= Each bag saves the equivalent of the number of plastic bottles indicated

= Chaque sac permet d'économiser l'équivalent du nombre de bouteilles plastiques indiqué



EVE
Design by Luca Artioli



TERA
Design by Luca Artioli



LC2200 EVE BACKPACK



Sac à dos anti-ivol - Compartiments pour ordinateur jusqu'à 15" et tablettes - Ouverture au dos - Pochette pour power bank avec passage pour fil et prise USB - Capacité : 22 L

30 x 18.5 x 40 cm / P.Brut: 670 g / Colisage: 12p / 8 kg

Anti-theft backpack - Compatible up to 15" laptop and tablet compartments - Back side opening - Power bank pocket with wire space and USB plug - Capacity: 22 L

11.8 x 7.28 x 15.7" / G.W: 1.47 lbs / Carton: 12 p / 17.63 lbs

LC2600 BACKPACK



Sac à dos - Poignée latérale - Compartiment pour ordinateur 15" - Dos renforcé - Multi poches - Capacité: 16 L

30 x 13 x 43 cm / P.Brut: 790 g / Colisage: 12p / 8.4 kg

Backpack - Side handle - 15" laptop compartments

- Reinforced back - Multi pockets - Capacity: 16 L

11.8 x 5.1 x 16.9" / G.W: 1.74 lbs / Carton: 12 p / 18.51 lbs

LC2602 GYM BAG



Sac à dos double compartiments - Usage sport et business - Compartiments ordinateur 15" et tablettes - Dos renforcé - Multi poches - Capacité: 23 L

30 x 17 x 45 cm / P.Brut: 900 g / Colisage: 12p / 10.4 kg

Double compartment backpack - For sport and business - 15" laptop and tablet compartments - Reinforced back - Multi pockets - Capacity: 23 L

11.8 x 6.7 x 17.7" / G.W: 2 lbs / Carton: 12 p / 22.93 lbs

LC2601 MESSENGER BAG



Sac messenger - Compartiment pour ordinateur 15" - Dos renforcé - Multi poches - Capacité: 19 L

40 x 18 x 27 cm / P.Brut: 700 g / Colisage: 12p / 7.4 kg

Messenger bag - 15" laptop compartment - Reinforced back - Multi pockets - Capacity: 19 L

15.7 x 7.08 x 10.6" / G.W: 1.54 lbs / Carton: 12 p / 16.31 lbs

LC2603 ORGANIZER POUCH



Pochette renforcée pour accessoires électroniques - Ouverture à plat

25 x 7 x 14 cm / P. Brut : 130 g / Colisage : 48 p / 6.2 kg

Reinforced pouch for electronic accessories - Flat opening

9.9 x 2.8 x 5.5" / G.W: 0.29 lbs / Carton: 48 p / 13.67 lbs

= Each bag saves the equivalent of the number of plastic bottles indicated

= Chaque sac permet d'économiser l'équivalent du nombre de bouteilles plastiques indiqué

PEANUT

Design by Luca Artioli



PACKABLE

Design by Margherita Matticari & Luca Artioli



LN1510 PEANUT BACKPACK



- X
- B
- K
- TR
- BG
- PR
- Y



B K TR



BG PR Y

Sac à dos repliable en pochette compacte - Capacité : 18 L

Sac à dos: 31 x 14 x 43cm / Plié en pochette: 14 x 2.5 x 24 cm / P. Brut : 260 g / Colisage : 48 p / 12.5 kg

Foldable backpack in a pouch - Capacity: 18 L

Backpack: 12.2 x 5.5 x 16.9" / Foldable in pouch: 5.5 x 0.98 x 9.4" / G.W: 0.57 lbs / Carton: 48 p / 27.56 lbs

LN1513 PEANUT DUFFLE BAG



- X
- B
- K

Sac de voyage repliable en pochette compacte - Capacité : 54 L

Sac de voyage: 57.5 x 30 x 35 cm / Plié en pochette: 27 x 6 x 14cm / P.Brut: 430g / Colisage: 48p / 20.6 kg

Travel bag foldable in a pouch - Capacity: 54 L

Duffle bag: 22.6 x 11.8 x 13.8" / Foldable in pouch: 10.62 x 2.36 x 5.51" / G.W: 0.95 lbs / Carton: 48 p / 45.41 lbs

LN1512 PEANUT GYM BAG



- X
- B
- K
- TR
- BG
- PR
- Y

Sac de gym repliable en pochette compacte - Capacité : 27 L

Sac de gym: 44 x 21 x 30 cm / Plié en pochette: 24 x 6 x 14 cm / P. Brut : 320 g / Colisage : 48 p / 15.3 kg

Gym bag foldable in a pouch - Capacity: 27 L

Gym bag: 17.3 x 8.3 x 11.8" / Foldable in pouch: 9.44 x 2.36 x 5.51" / G.W: 0.76 lbs / Carton: 48 p / 33.73 lbs



NC NN B K BG

LC2310 PACKABLE DUFFLE

Design by Margherita Matticari



- NC
- N
- B
- K
- BG

Sac de voyage cylindrique repliable en pochette compacte - Capacité : 21 L

Sac cylindrique: Ø 20.5 x 50 cm Plié en pochette: Ø 20.5 x 1.4 cm / P. Brut : 170 gr / Colisage : 48 p / 8.2 kg

Foldable duffle bag - Capacity: 21 L

Duffle bag: Ø 8 x 19.6" / Foldable in pouch: Ø 8 x 0.5" / G.W: 0.37 lbs / Carton: 48 p / 18.07 lbs



LC2311 PACKABLE BACKPACK

Design by Luca Artioli



- NC
- N
- B
- K
- BG

Sac à dos repliable en pochette compacte - Capacité : 15 L

Sac à dos: 29 x 13 x 41 cm / Plié en pochette: 15 x 1.4 x 18.5 cm / P.Brut: 305 g / Colisage: 40p / 12.2 kg

Foldable backpack - Capacity: 15 L

Backpack: 11.4 x 5.2 x 16.1" / Foldable in pouch: 5.9 x 0.5 x 7.2". G.W: 0.67 lbs / Carton: 40 p / 26.89 lbs



Plié en pochette
Foldable in pouch

LL114 NEO LUGGAGE TAG

Design by Kazuya Koike



Étiquette bagage avec lanière en gomme -
Matériaux : aluminium / gomme. Marquage
conseillé : sérigraphie - laser

3,3 x 0,7 x 8,8 cm | P.Brut: 45 g / Colisage :
160p / 4,5kg

Luggage tag with rubber string - Material:
aluminium / rubber. Suggested branding:
silkscreen - laser

1.3 x 0.3 x 3.5" | G.W: 0.1 lbs | Carton: 100 p /
9.92 lbs



CUSTOMIZE YOUR LEXON BAG

PERSONNALISEZ VOTRE SAC LEXON

Discover our range of over-plates* customizable with your logo on request when placing your order.

Découvrez notre gamme de sur-plaques* personnalisables avec votre logo sur demande à la commande.



*Patented system / Système breveté

ONE+



31mm x 19mm
1.2 x 0.7"

PREMIUM+



33 x 18 mm
1,3 x 0,7"

TRACK



32 mm x 13 mm
1.2 x 0.5"

CHALLENGER



60 mm x 9 mm
2.4 x 0.4"

EVE



Ø 37 mm
Ø 1.4"

TERA



40 x 31,5 mm
1,6 x 1,2»

PEANUT



44 mm x 34 mm
1.7 x 1.3"

PACKABLE



Ø 28 mm
Ø 1.1"

Additional branding techniques available for bags:

- Silkscreen on fabric
- Digital printing

Autres techniques de marquage disponibles pour la bagagerie:

- Sérigraphie sur tissu
- Impression numérique

LEXON® × Keith Haring



LEXON® × JEAN-MICHEL BASQUIAT



Keith Haring™



COLLABORATIONS *COLLABORATIONS*

Drawing inspiration from Keith Haring's artistic style, characterized by bold lines, vibrant colors, and symbolic icons, Lexon has skillfully translated Haring's vision into tangible, everyday objects. This collaboration pays homage to Haring's belief that art should be accessible to all, bringing his iconic imagery into the realm of practical, everyday use.

S'inspirant du style artistique de Keith Haring, caractérisé par des lignes audacieuses, des couleurs vibrantes et des icônes symboliques, Lexon a habilement traduit la vision de l'artiste à travers ses objets tangibles du quotidien. Cette collaboration rend hommage à la conviction de Haring selon laquelle l'art doit être accessible à tous, amenant son imagerie emblématique dans le domaine de l'utilisation pratique et quotidienne.



LIMITED-RUN PRODUCTION GIFT SETS *COFFRETS EN SÉRIE LIMITÉE*

Limited in production, this exclusive gift set includes all four Lexon products capturing the essence of Keith Haring's masterpieces.

Produit en série limitée, ce coffret cadeau exclusif comprend les quatre produits Lexon capturant l'essence des chefs-d'oeuvre de Keith Haring.

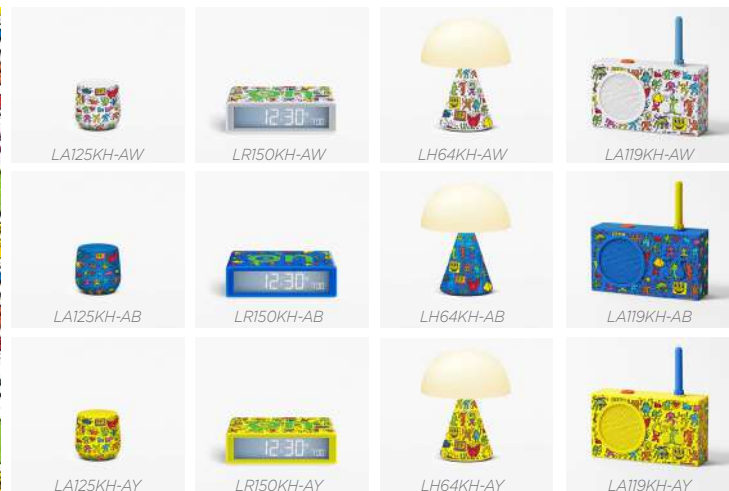

JEAN-MICHEL BASQUIAT™



COLLABORATIONS COLLABORATIONS

Pursuing our commitment to blend design and tech, we have reimagined our most popular objects to feature some of Jean-Michel Basquiat's iconic works. This exclusive collaboration embraces Lexon's inherently forward-thinking nature, seamlessly merging it with the artist's bold and exuberant style. The result is an inspiring fusion that celebrates art and creativity in everyday life, forging an harmonious symphony that unites form and function in an extraordinary manner.

Poursuivant notre engagement à allier design et technologie, nous avons réinventé nos objets les plus populaires pour présenter certaines des oeuvres emblématiques de Jean-Michel Basquiat. Cette collaboration exclusive embrasse la nature intrinsèquement avant-gardiste de Lexon, la fusionnant de manière transparente avec le style audacieux et exubérant de l'artiste. Le résultat est une fusion inspirante qui célèbre l'art et la créativité au quotidien, forgeant une symphonie harmonieuse qui unit forme et fonction d'une manière extraordinaire.



LIMITED-RUN PRODUCTION GIFT SETS COFFRETS EN SÉRIE LIMITÉE

Limited in production, this exclusive gift set includes all four Lexon products capturing the essence of Jean-Michel Basquiat's masterpieces.

Produit en série limitée, ce coffret cadeau exclusif comprend les quatre produits Lexon capturant l'essence des chefs-d'oeuvre de Jean-Michel Basquiat.

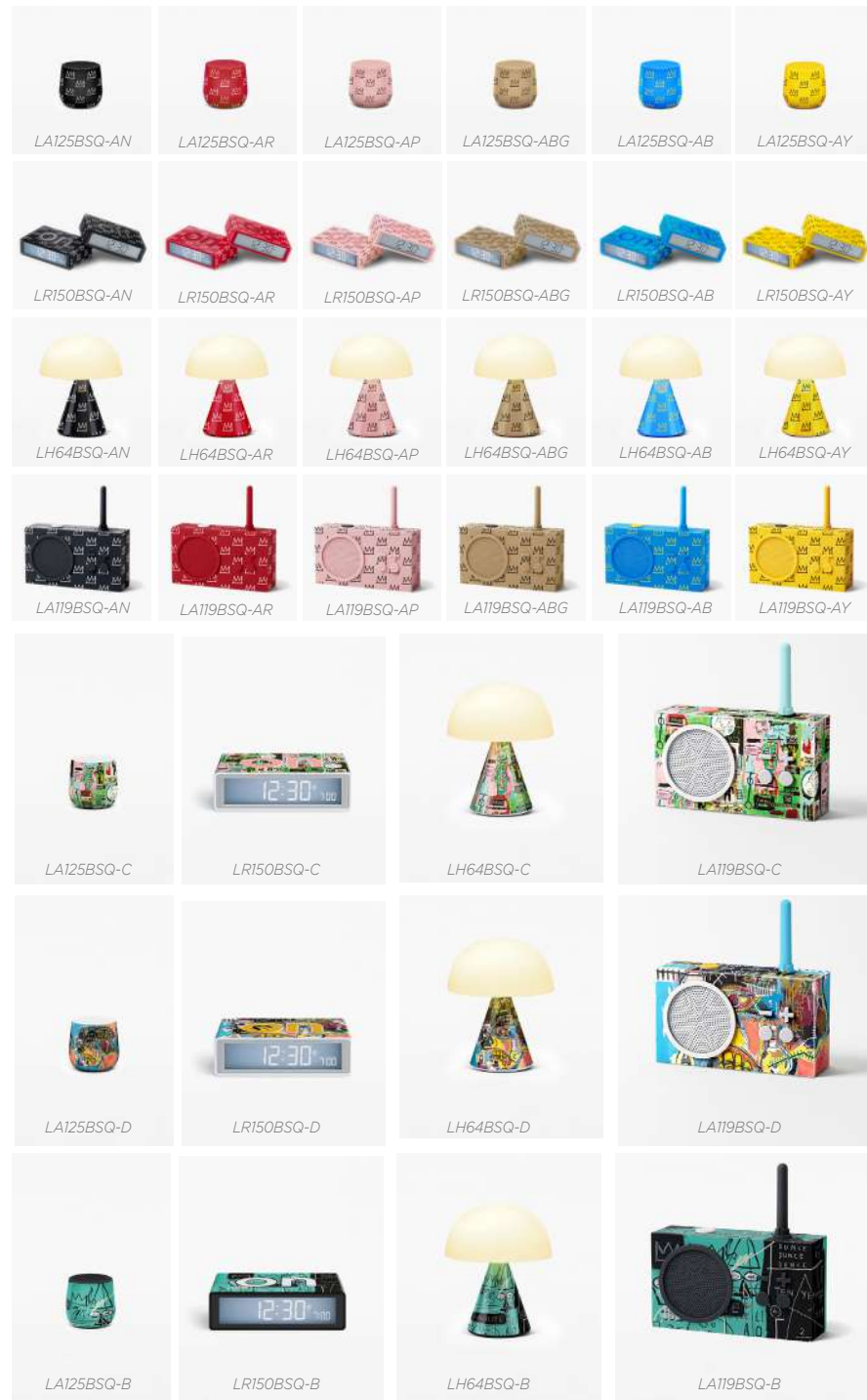
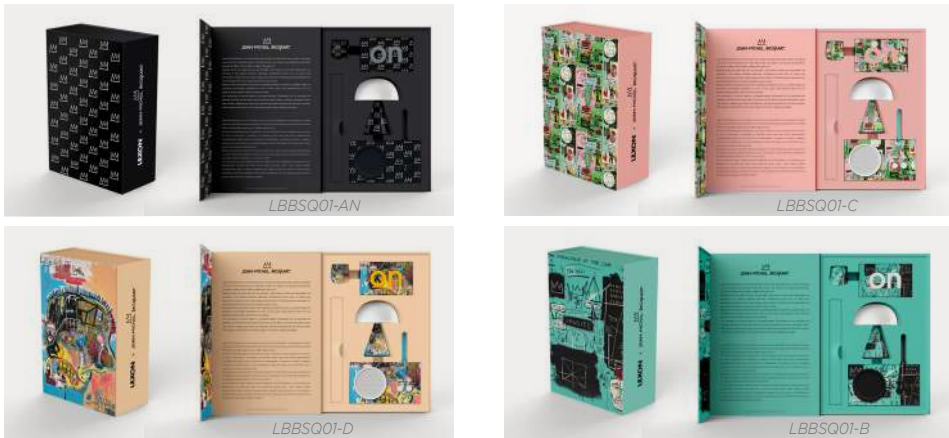

MATERIALS
MATÉRIAUX



ANODIZED ALUMINUM

LA125 MINO+



LA129 MINO+ L



LA131 TAMO



LL134 WINO



LH89 ROMINO



LD149 MUSO



LL158 METALI-C



LR152 FLIP PREMIUM



LR154 MINUT



LA132 RAY SPEAKER



LR155 RAY CLOCK



LR156 CONIC CLOCK



LH100 CONIC LAMP



LA133 CONIC SPEAKER



LH60 MINA



LH64 MINA M



LH65 MINA L



LH76 MINA L AUDIO



LR153 MINA SUNRISE



LH96 LUMA S



LH87 LUMA M



LH97 LUMA L



LH98 LUMA XL



LH99 MIMI



LH95 STELI



LH70 BUBBLE LAMP



LA134 TERRACE+



LH102 HELIA

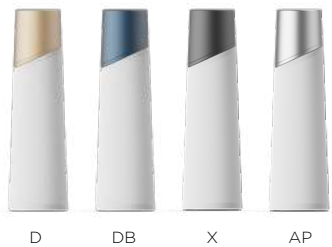

LH103 BIRDY



LL160 TECLA



LS64 SCRIBALU



LL129 FINE BAG LIGHT 2



LL130 FINE TUBE POWER BANK 2



LD135 CITY RULER

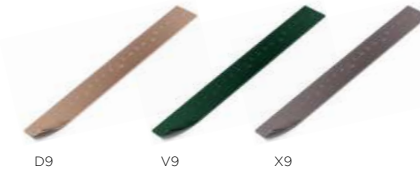

LD138 CITY DESK TRAY



LD137 CITY CARD STAND



LD14 CARD BOX



LD139 CITY TAPE DISPENSER



LD140 CITY PEN CUP



LL147 NOMADAY UV STRAW



LL156 NOMADAY PICNIC SET



LH77 HORIZON HANGING LAMP



LH78 HORIZON SAFETOUCH

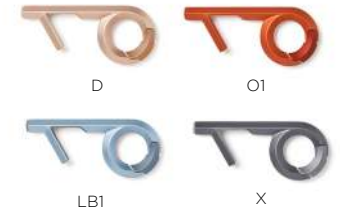

LL157 NOMADAY PILLBOX



LD144 NOMADAY CARD



LL148 HORIZON THERMO BOTTLE



LH83 NOMADAY UV DRINK



LH85 HORIZON DIFFUSER



LH91 HORIZON DISPENSER



LL138 NOMADAY POWER BANK



LL137 NOMADAY FLASH



LL136 NOMADAY LIGHT



LL128 NOMADAY LOCK



LH84 HORIZON MAGSPRAY

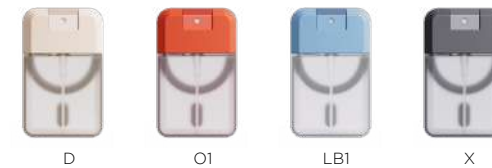

COLORS

LR150 FLIP+



LR151 FLIP+ TRAVEL



LA123 MINO S



LA124 MINO T



LA120 MINO X



LA119 TYKHO 3



LD150 PEAS HUB C

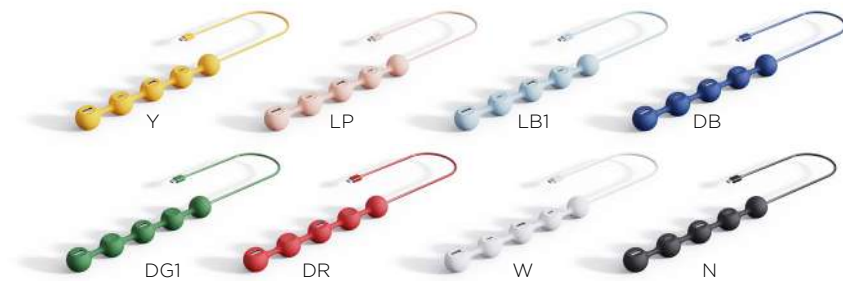

LL161 PEAS POWER



LU21 MINI HOOK UMBRELLA



CLASSIC / BASIC COLORS

LH63 **BOLLA+**



LL121 **LUCIE**



LH88 **ORBE**



LH79 **MANO**



LH90 **DIVA**



LD146 **UNO MINI CHARGER**



LD147 **DUO MINI CHARGER**



LH59 **OBLIO**



LH69 **OBLIO BOX**



LH68 **OBLIO DUO**



LH104 **ARIA**



GLOSSY

LA125 **MINO+**



LA124 **MINO T**



LS101 **C-PEN**



LH60 **MINA**



LH64 **MINA M**



LH65 **MINA L**



LS102 **C-PEN STYLUS**



SYNTHETIC LEATHER

LA127 **SPEAKERBUDS**



LL153 **SOFTPOWER MAGBANK**



LL142 **SOFTPOWER WIRELESSBANK**



LA128 **POWERSOUND**

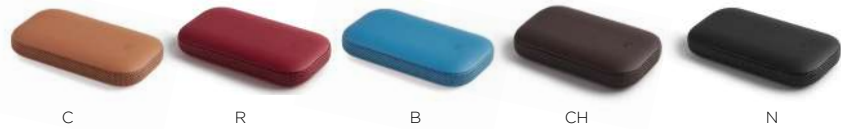

LL141 **OSLO ENERGY+**



LL152 **POWERON**



LH66 **OBLIO WALLET**



LA130 **OSLO NEWS PREMIUM**



LD145 **CITY ENERGY PRO**



LL148 **CITY LIGHT**



LH94 **LANTERN**



WOOD

LH39 **ZEN CUP**



LH40 **ZEN LARGE CUP**



LH42 **ZEN COTTON BOX**



LH43 **ZEN TISSUE BOX**



SALES & MERCHANDISING TOOLS

SUPPORTS D'AIDE À LA VENTE

With our range of displays, enhance the presentation of our Lexon products in your store.
We offer solutions tailored to the size and style of your retail space.

*Avec notre gamme de displays, sublimes la présentation de nos produits Lexon dans votre magasin.
Nous proposons des solutions adaptées à la taille et au style de votre espace de vente.*

ACRYLIC DISPLAYS PRÉSENTOIRS EN ACRYLIQUE



LAD105
6 x MINO+

LAD106
12 x MINO+



LAD111
MINO+ / TWIN MINO+
MINO X / MINO L / MINO T



LAD107
MINO T



LAD108
4 x MINO X



LAD112
MINO+ / MINA M



LAD77
4 x MINA



LAD78
8 x MINA



LAD39B
3 x TYKHO 3



LAD48
6 x FLIP+



LAD64
6 X FLIP+ TRAVEL



LAD31B
DISPLAY FOR BAGS



LAD76
LEXON BLOCK MARK



LAD129 TO LAD146
PRODUCT BLOCK MARK

CARDBOARD DISPLAYS CHEVALETS EN CARTON



297 x 210 mm

LAD88
MINA



297 x 210 mm

LAD94
MINO X



297 x 210 mm

LAD99
TYKHO 3

COUNTER DISPLAYS* PLV DE COMPTOIR*



495 x 300 x 300 mm

WOODEN FURNITURE* MOBILIER EN BOIS*



81 x 81 x 118 cm

*on order only / sur commande uniquement

CORPORATE GIFTS

CADEAUX D'AFFAIRE

We design, develop and manufacture corporate gift objects to serve the needs of leading companies and brands.

Nous concevons, développons et fabriquons des cadeaux d'affaire pour répondre aux besoins des grandes entreprises et des marques.



EQUIP YOUR TEAM
ÉQUIPEZ VOS COLLABORATEURS



PROMOTE YOUR BUSINESS
FAITES LA PROMOTION DE VOTRE ENTREPRISE



REWARD YOUR STAFF
RÉCOMPENSEZ VOTRE ÉQUIPE

BRANDING TECHNIQUES

TECHNIQUES DE PERSONNALISATION



SILKSCREEN
SÉRIGRAPHIE



LASER
LASER



LASER ON PLATE
LASER SUR PLAQUE



GEL INK
ENCRE GEL



PAD INK
TAMPOGRAPHIE



DIGITAL PRINTING
IMPRESSION DIGITALE

YOUR PROJECT

VOTRE PROJET

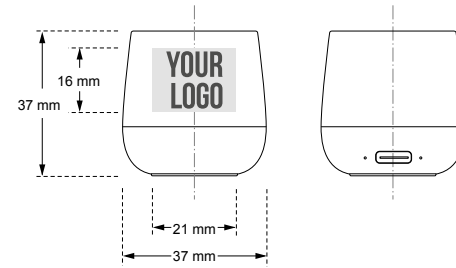

BRANDING ON PRODUCT*
PERSONNALISATION DU PRODUIT*



BRANDING ON PACKAGING**
PERSONNALISATION DU PACKAGING**

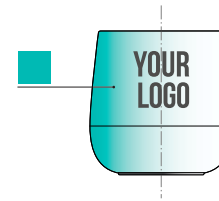

SPECIAL COLOR DEVELOPMENT***

DÉVELOPPEMENT D'UNE COULEUR PERSONNALISÉE***

*50 pcs / **3000 pcs / ***5000 pcs



SPECIAL KIT CREATION

CRÉATION DE KIT THÉMATIQUE

THEY TRUST US

ILS NOUS FONT CONFIANCE

SAINT LAURENT PARIS

KENZO

AIRBUS

AUDEMARS PIGUET
Le Brassus

ZARA HOME



PHILIP MORRIS INTERNATIONAL



Emirates

UBS

carhartt

Hertz

T-Mobile

intel.

LEXON®

DESIGN OBJECTS

Since its creation in 1991, Lexon has relentlessly pushed the limits and created a difference in the world of design while remaining true to its commitment to make small objects useful, beautiful, innovative and affordable. Whether in electronics, audio, office, leisure and travel accessories, Lexon has established a special relationship with creativity and partnered with the best designers around the world to create timeless collections of lifestyle products. Today, with more than 30 years of existence, more than 200 awards, collaboration with some of the most renowned designers, a retail presence in more than 90 countries across the Globe, Lexon has truly established itself as a worldly-known French design brand.



BOW GROUP

BOW Group with its **4 offices around the world** - Paris, Geneva, Miami and Shenzhen - is a **global player and multi-skilled platform** with design, development, manufacturing and distribution capabilities, which offers solutions answering the needs of our modern lifestyles. With more than 2 million pieces sold every year, BOW aims to become a **world leader in lifestyle products and accessories in all their forms**: connected, design, art; with its **two consumers brands Lexon and MyKronoz**, its **two retail concepts** that are **Legacy** and **Musart**, as well as **BOW Industries**, its **R&D center** that owns 70 design patents.

MYKRONOZ

CONNECTED OBJECTS

Founded in 2013, MyKronoz focuses on consumer IoT with a wide portfolio spanning from wearables, mainly with activity trackers and hybrid watches, as well as smart products for the home. To date, our Swiss brand has sold 3M of connected devices with its own cloud architecture and proprietary mobile app. Over the past three years, MyKronoz has won 3 Red Dot Design Awards and 2 iF Design Awards, proving its expertise in designing smart objects and meaningful experiences that enhance people's lives.



mykronoz.com

MUSART

ART OBJECTS

Musart is a fast-growing art marketplace to buy original artworks and licensed products. Since its inception in 2014, the mission of this online destination is to make art accessible, giving anyone the opportunity to own a piece of museum. Partnerships with world-class institutions and cultural organizations allow Musart to bring not only exclusive and authentic items, but also, to honor iconic artists.

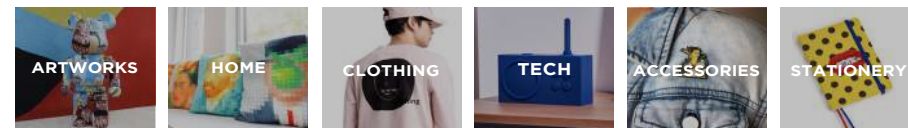

musart.com

LEGACY

LUXURY OBJECTS

Legacy is an exclusive hybrid concept store boasting a sharply curated selection of products comprising multiple categories such as watches, jewelry, art, tech, books, eyewear, beauty and more. We work both with well-established brands and young emerging talents to offer a unique selection of exceptional items and creations.

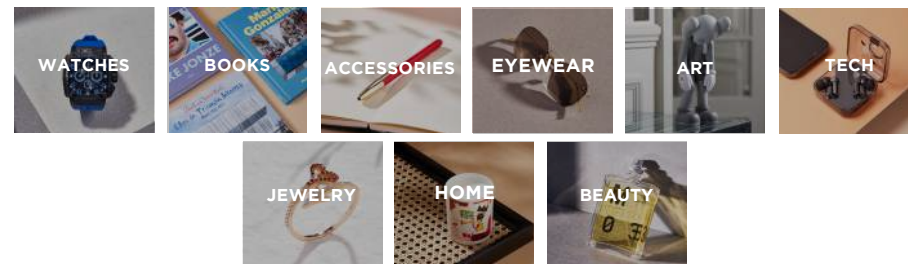

store-legacy.com

LEXON®



LEXON - 125 Avenue des Champs-Élysées 75008 Paris France

lexon-design.com | [@lexondesign](https://www.instagram.com/lexondesign)